

①

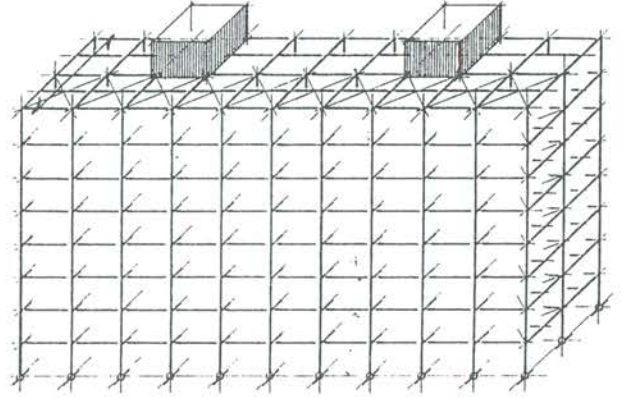

②

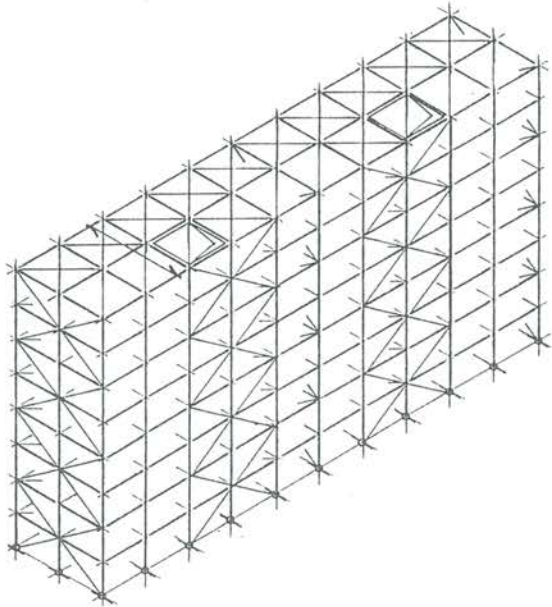

③

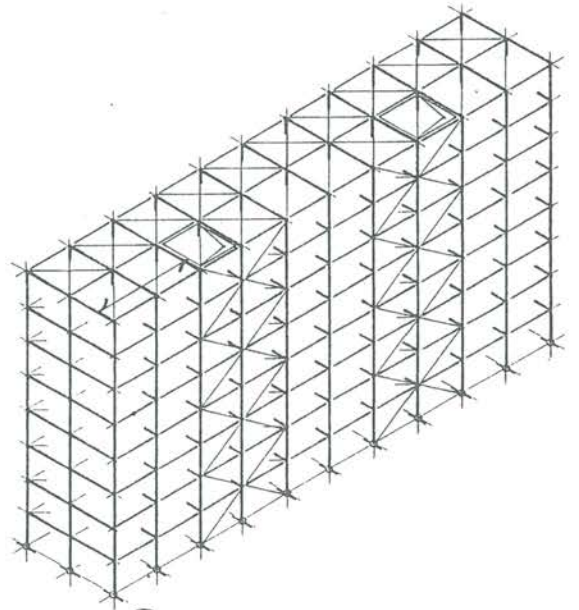

④

SISTEMI STRUTTURALI
DELL'EDILIZIA CIVILE

- 1 - EDIFICIO MULTIPIANO IN ACCIAIO
CON NUCLEI IN C.A.
SCHEMA STATICO "PENDOLARE"

- 2 - EDIFICIO MULTIPIANO IN ACCIAIO
CON NUCLEI IN C.A.
SCHEMA STATICO "A TELAI TRASVERSALI"

- 3 - EDIFICIO MULTIPIANO CON STRUTTURE
REALIZZATE TOTALMENTE IN ACCIAIO
SCHEMA STATICO "PENDOLARE"

- 4 - EDIFICIO MULTIPIANO CON STRUTTURE
REALIZZATE TOTALMENTE IN ACCIAIO
SCHEMA STATICO "A TELAI TRASVERSALI"

1- EDIFICIO MULTIPIANO IN ACCIAIO
CON NUCLEI IN C.A.

SCHEMA STATICO "PENDOLARE"

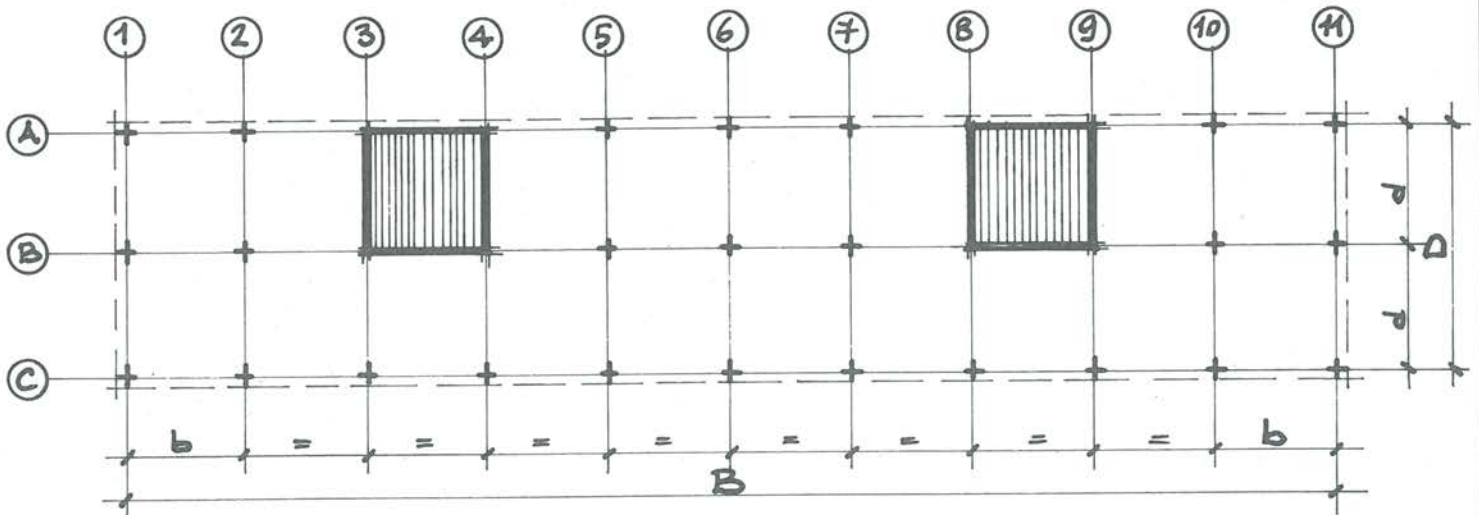

PIANO TERRA

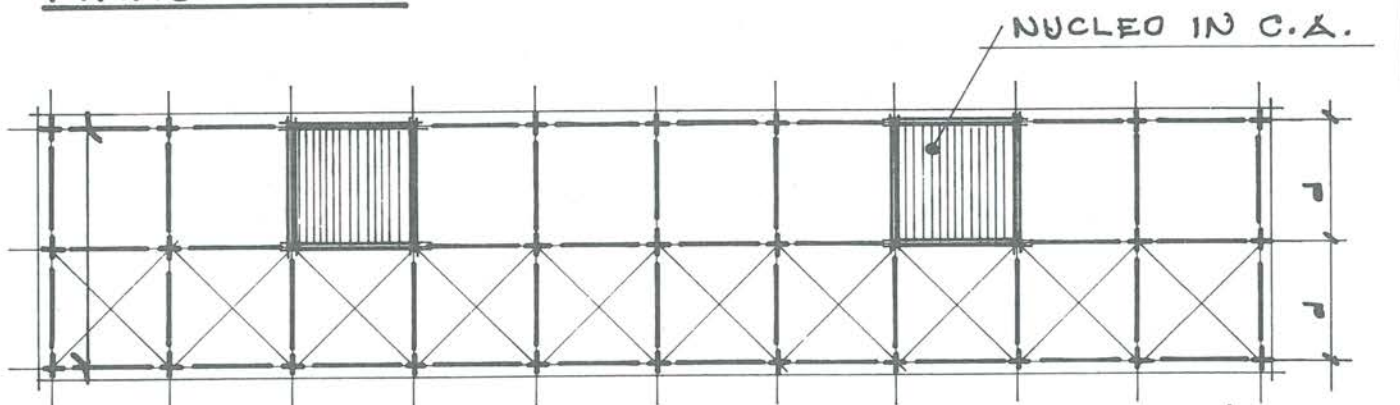

PIANO TIPO - ORDITO STRUTTURALE: SOLUZIONE α

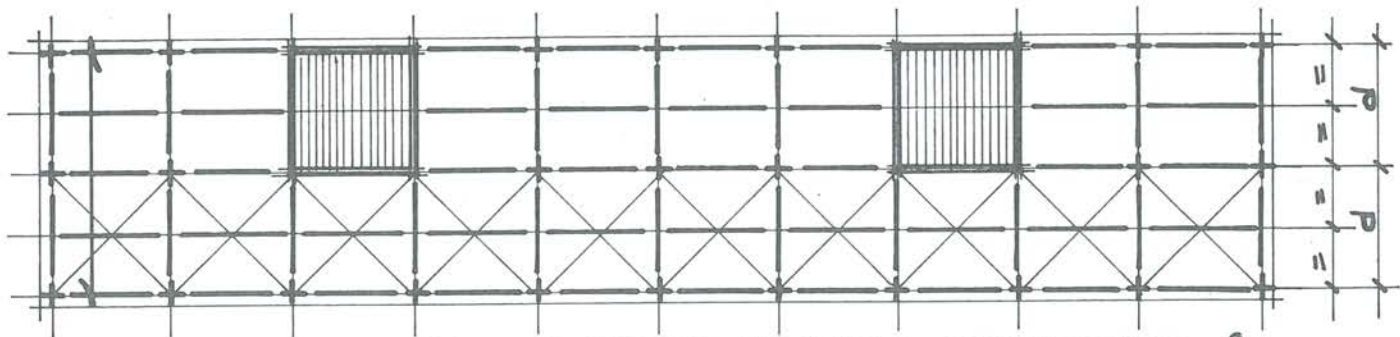

ORDITO STRUTTURALE: SOLUZIONE β

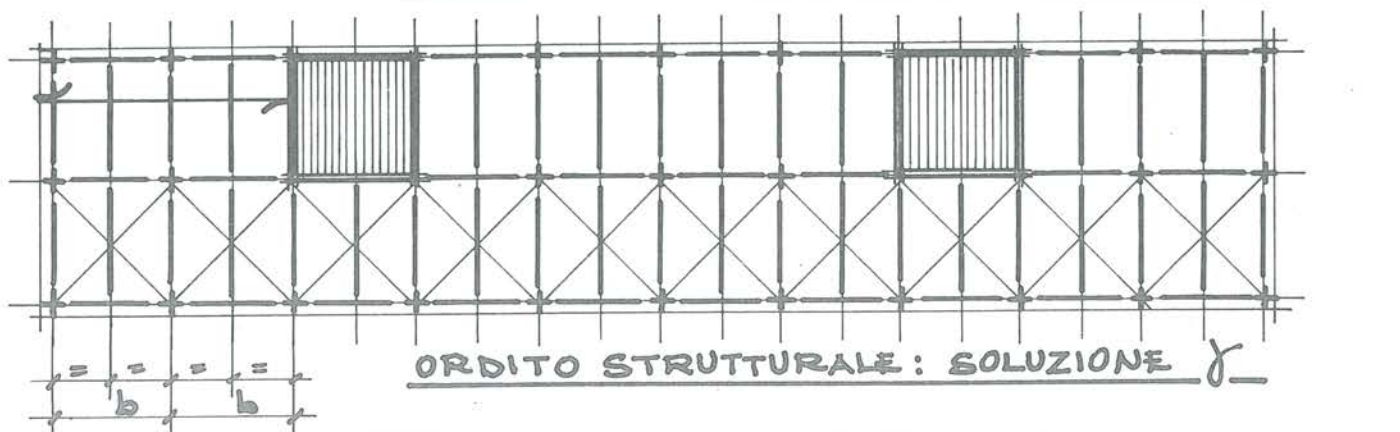

ORDITO STRUTTURALE: SOLUZIONE γ

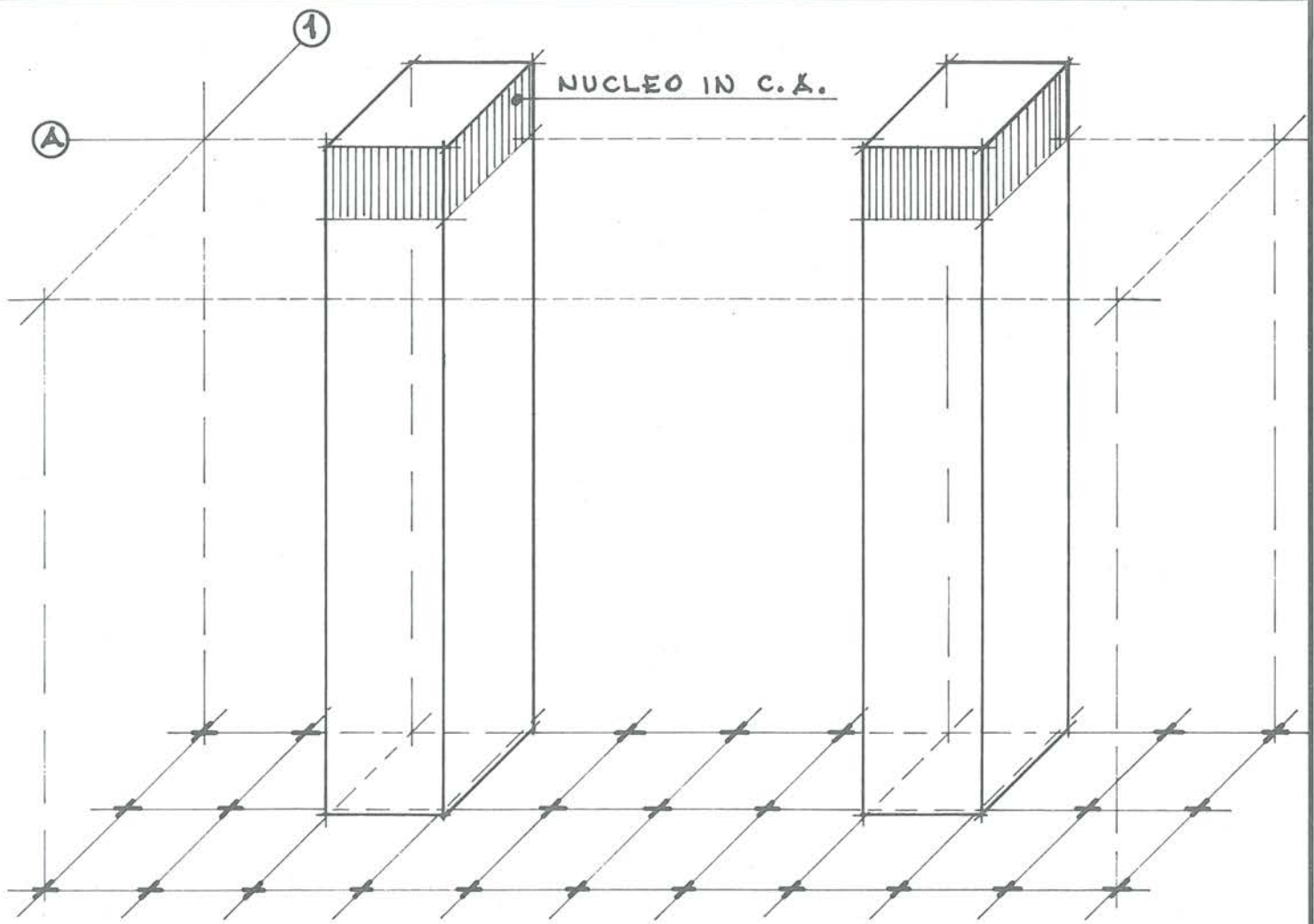

SOLUZIONE α — VISTA ASSONOMETRICA

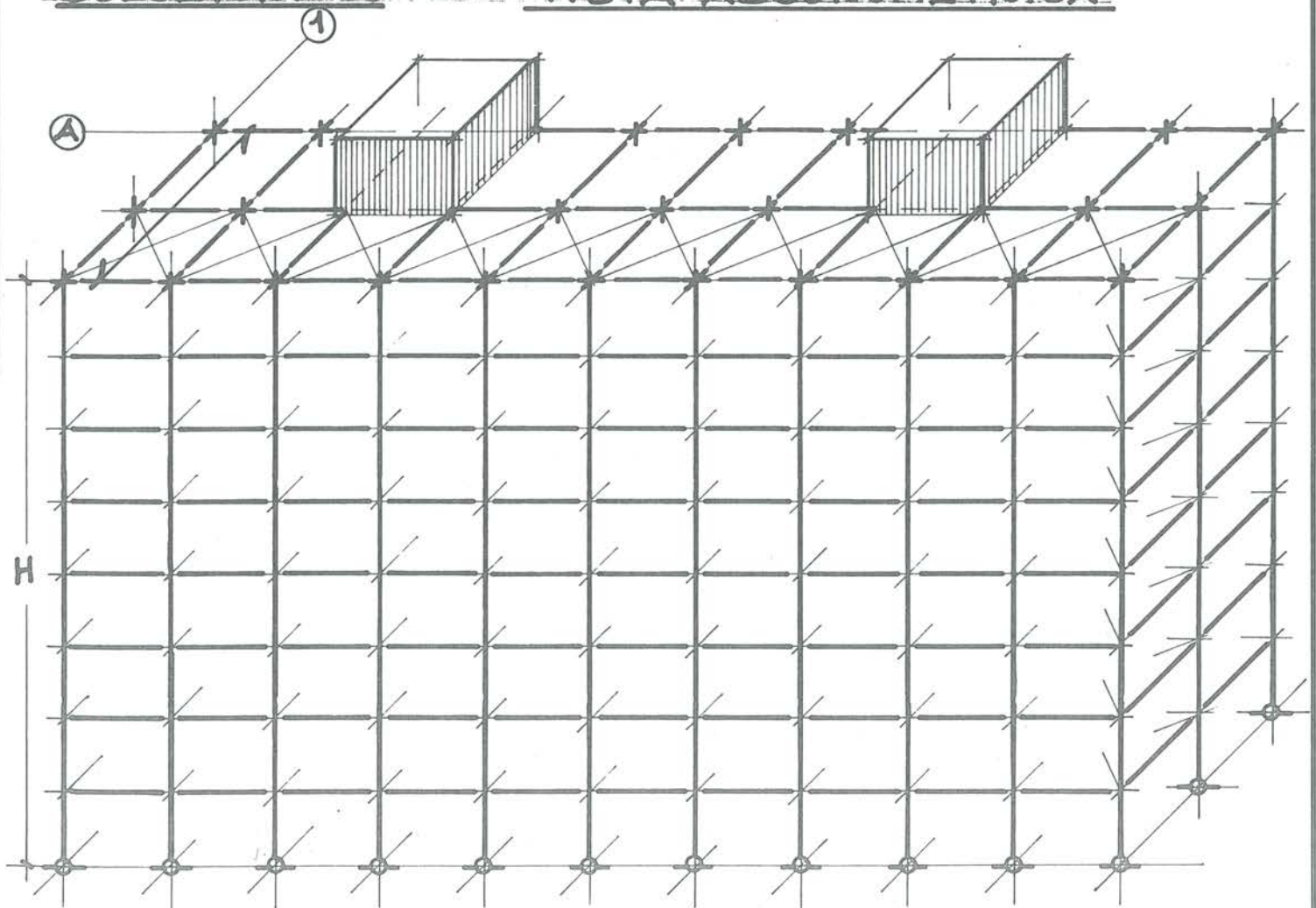

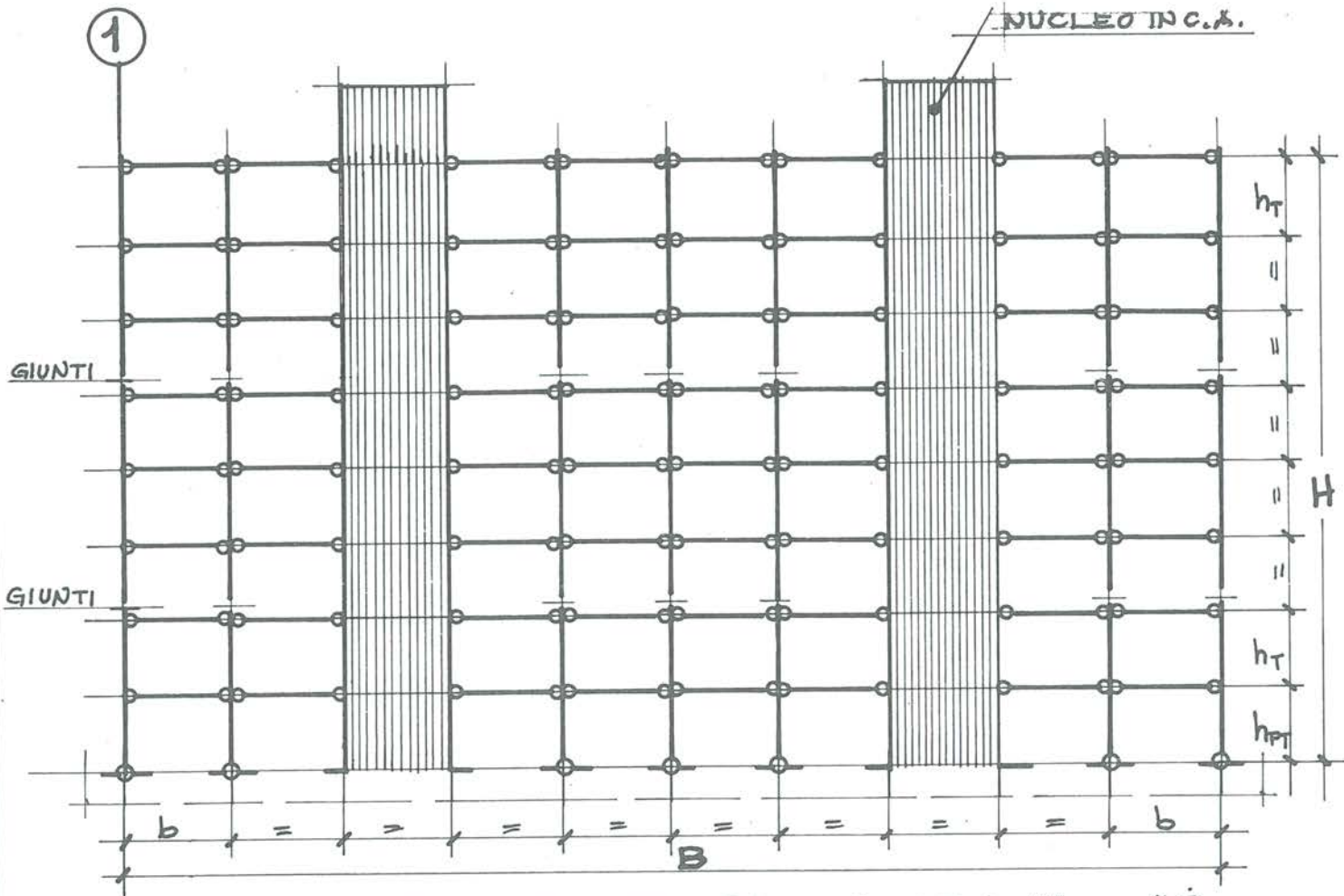

SCHEMA STRUTTURALE AI FILI "A" - "B"

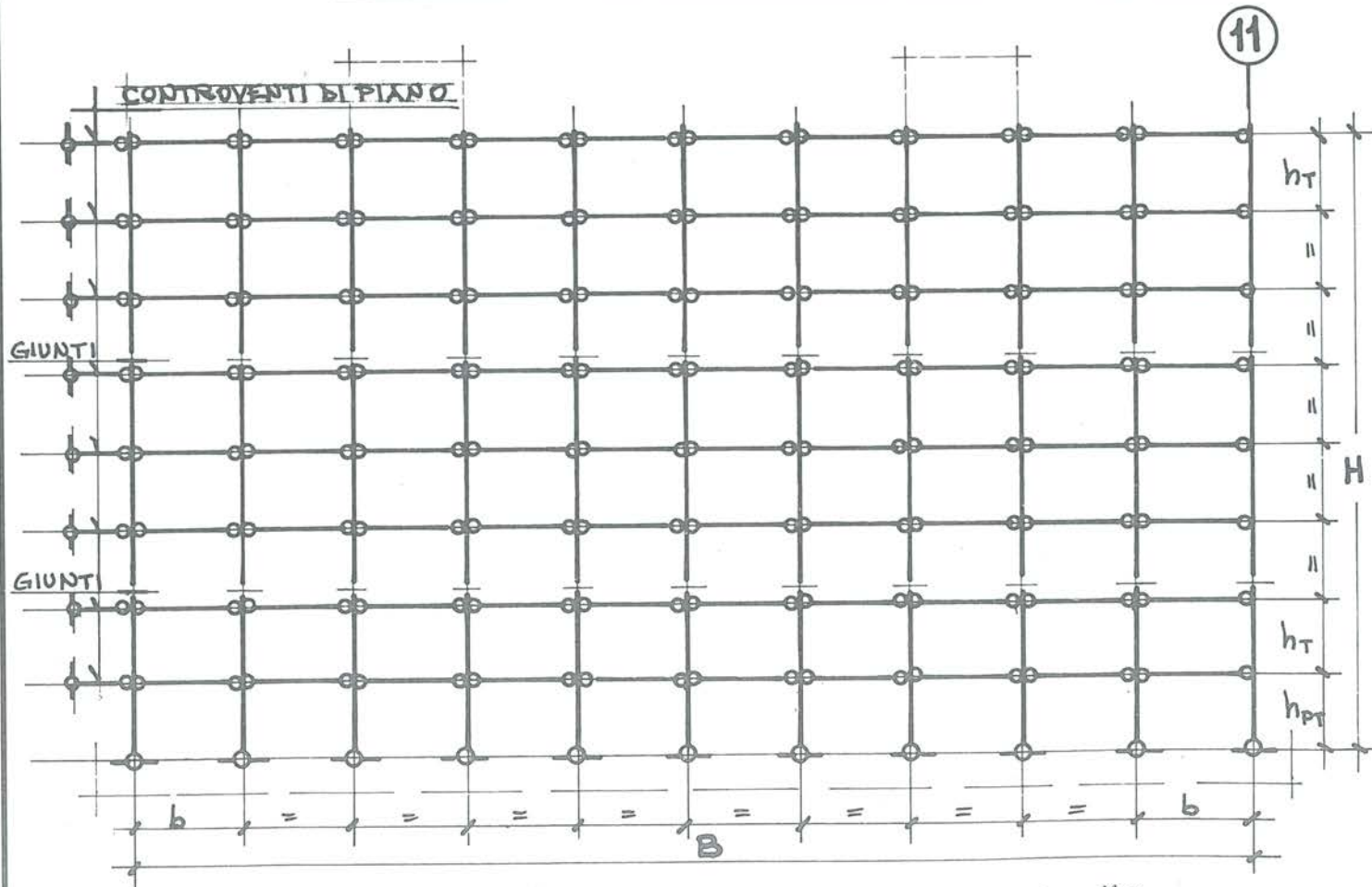

SCHEMA STRUTTURALE AL FILO "C"

SOLUZIONE α

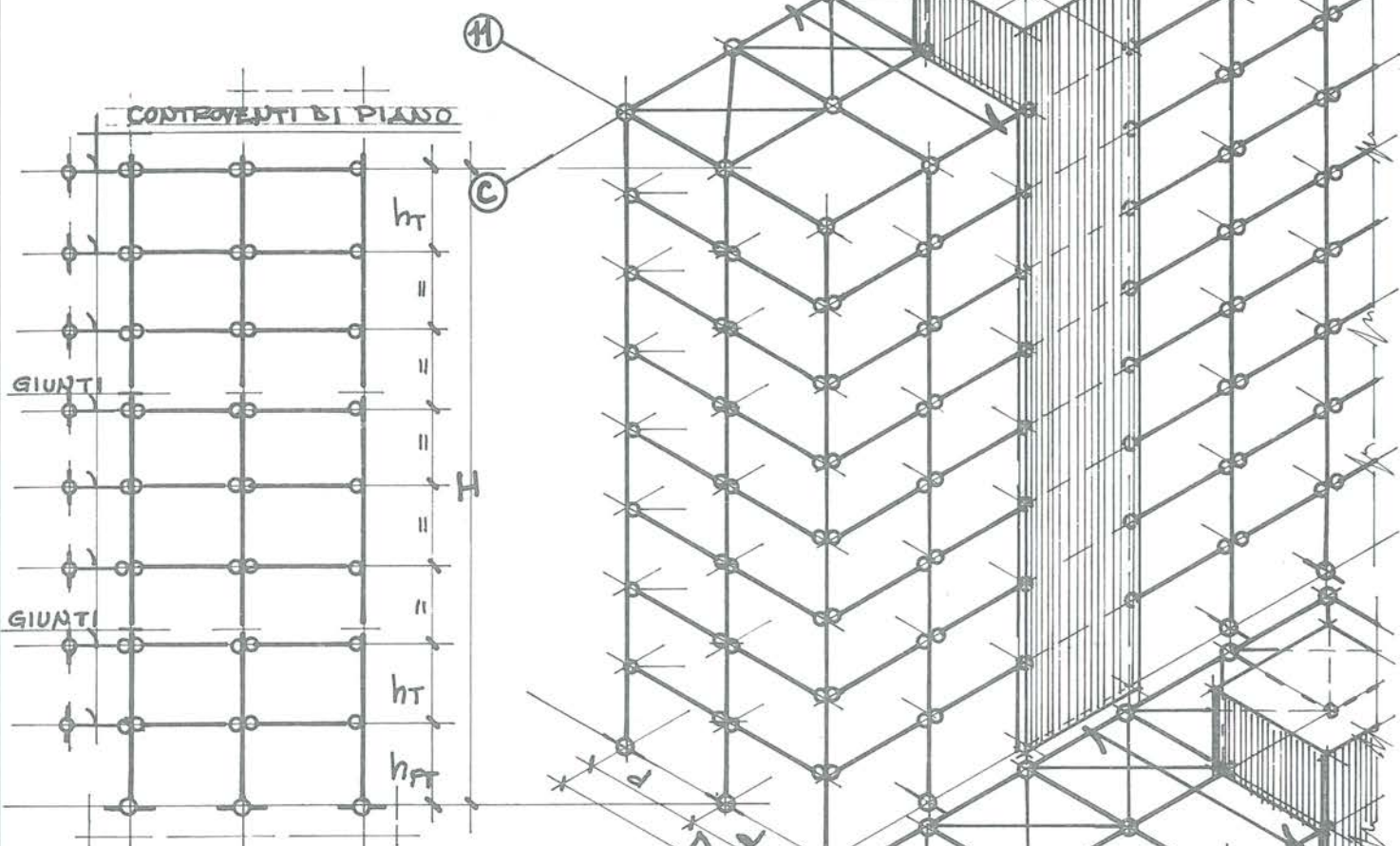

SCHEMA STRUTTURALE AI PICCHETTI
#1-2-5-6-7-10-11

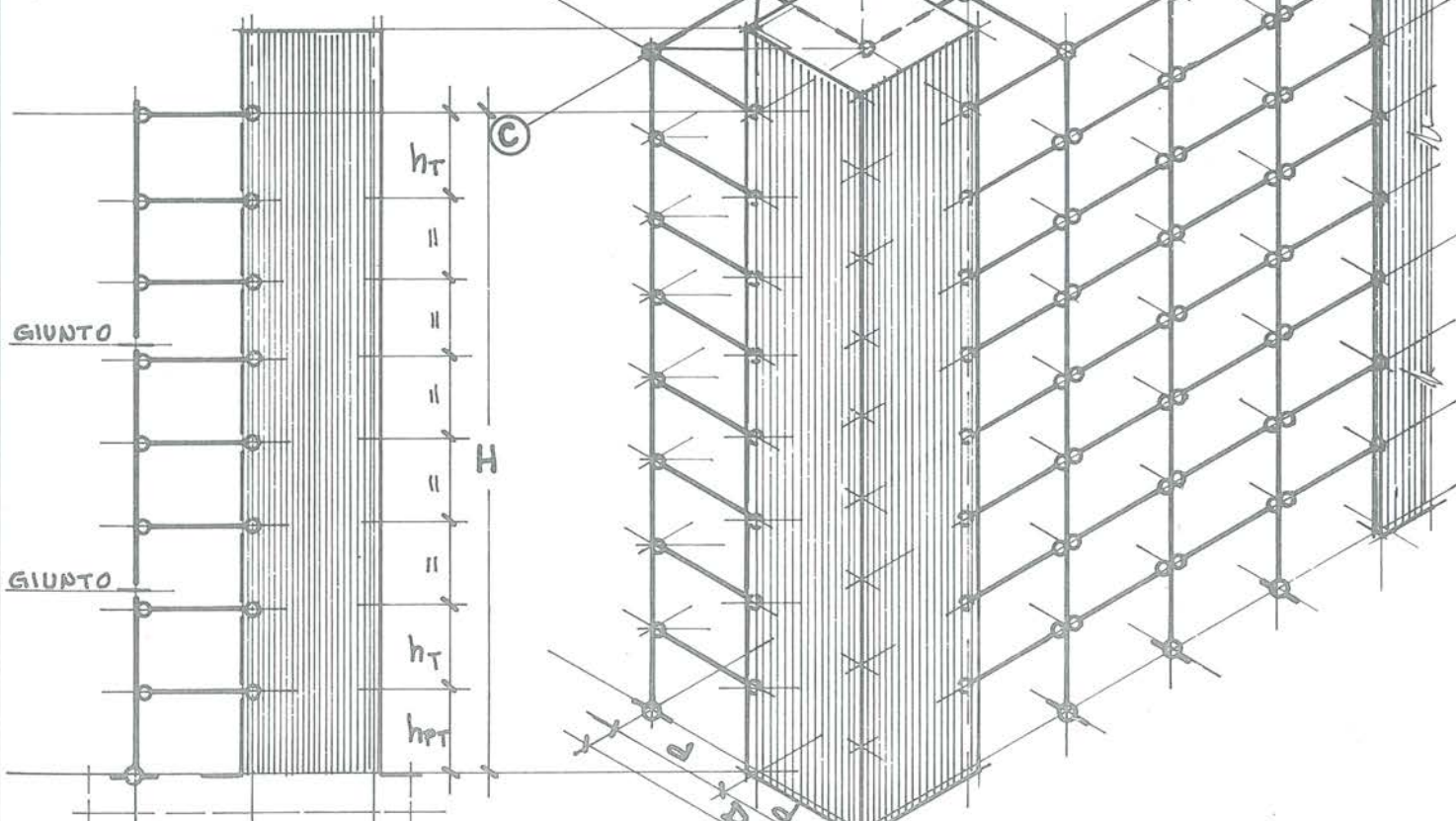

SCHEMA STRUTTURALE AI PICCHETTI
#3-4-8-9

2- EDIFICIO MULTIPIANO IN ACCIAIO
CON NUCLEI IN C.A.

SCHEMA STATICO "A TELAI TRASVERSALI"

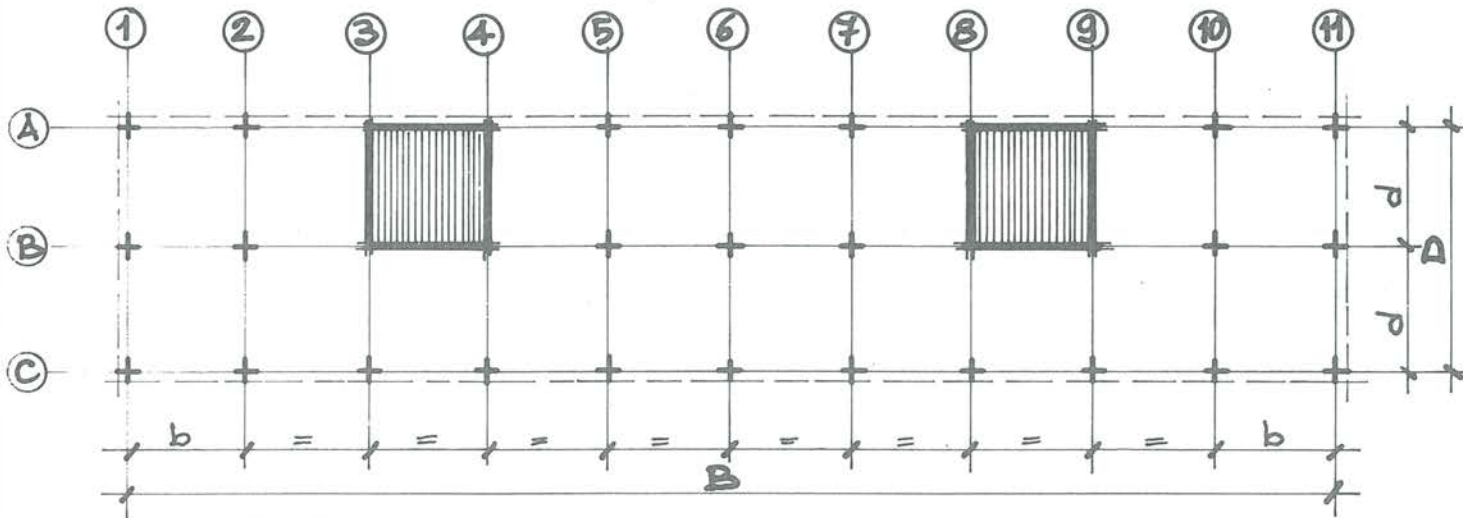

PIANO TERRA

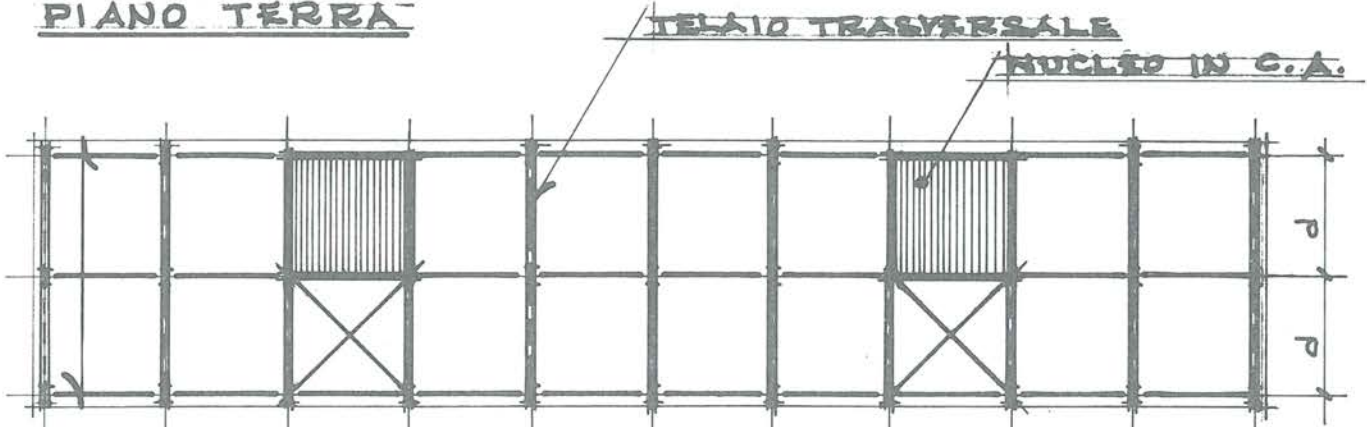

PIANO TIPO - ORBITO STRUTTURALE: SOLUZIONE α

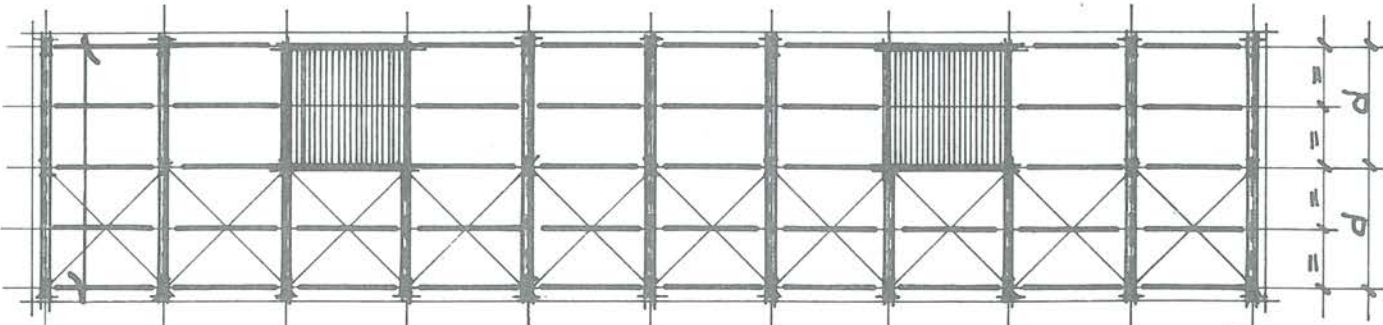

ORDITO STRUTTURALE: SOLUZIONE β

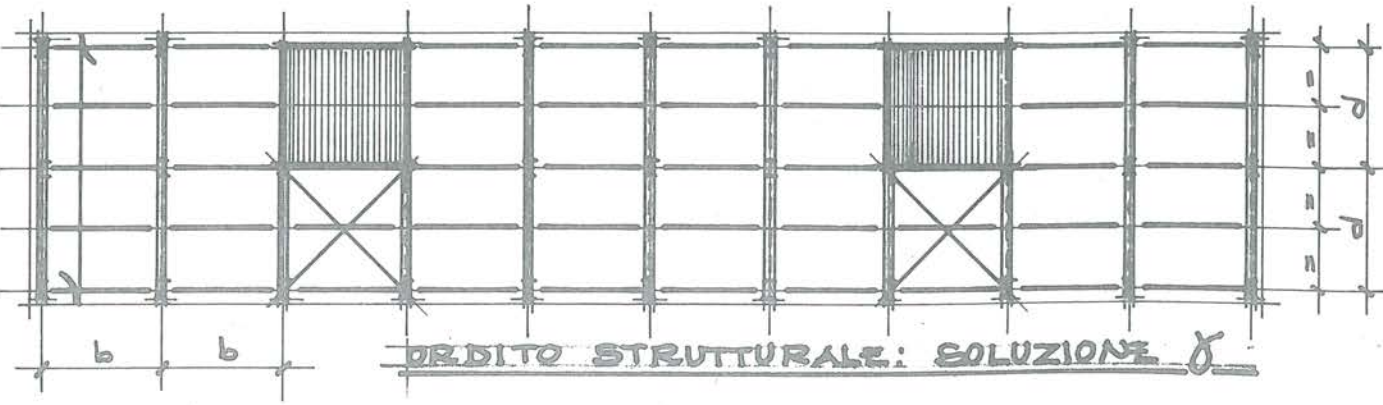

ORDITO STRUTTURALE: SOLUZIONE γ

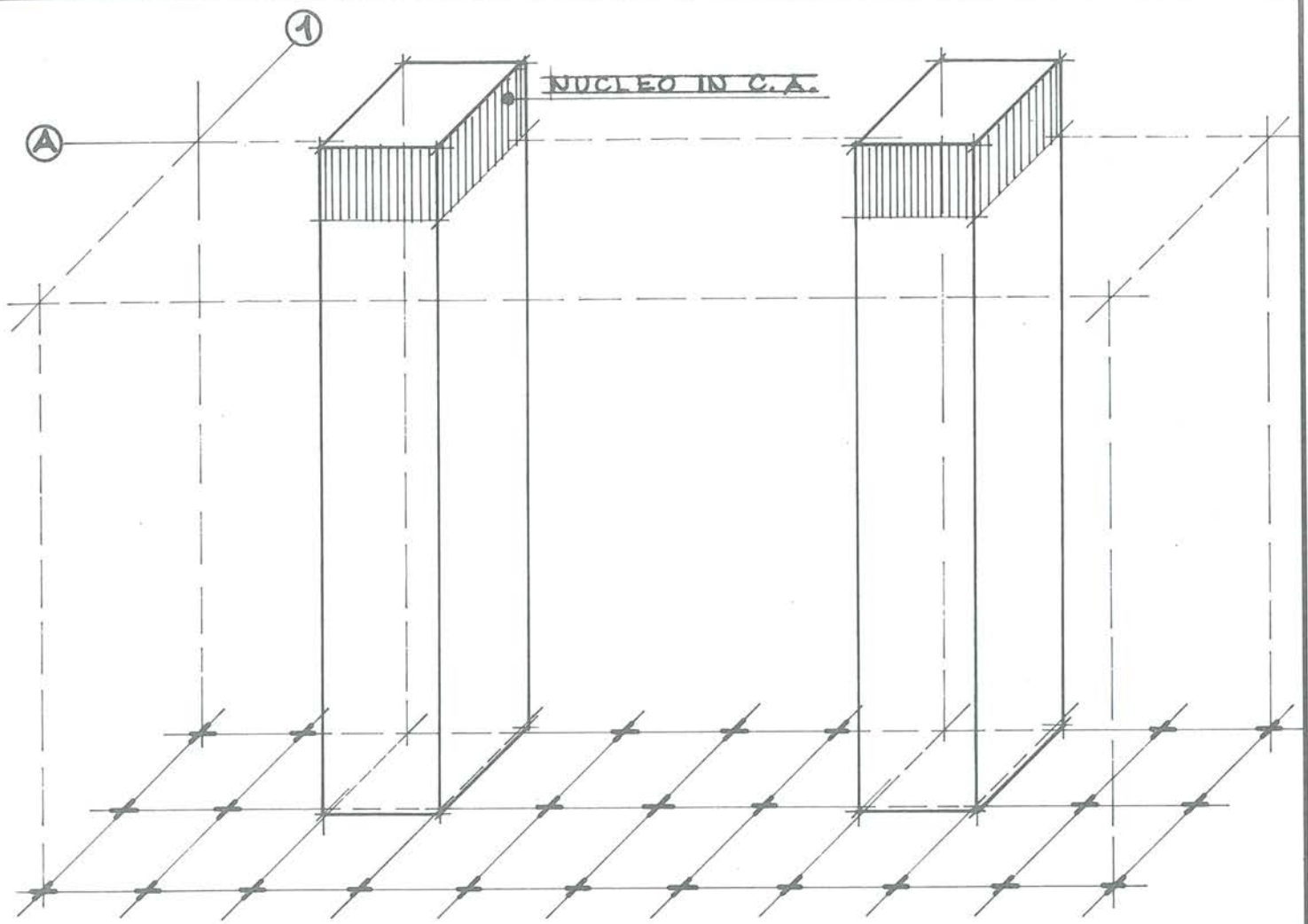

SOLUZIONE B - VISTA ASSONOMETRICA

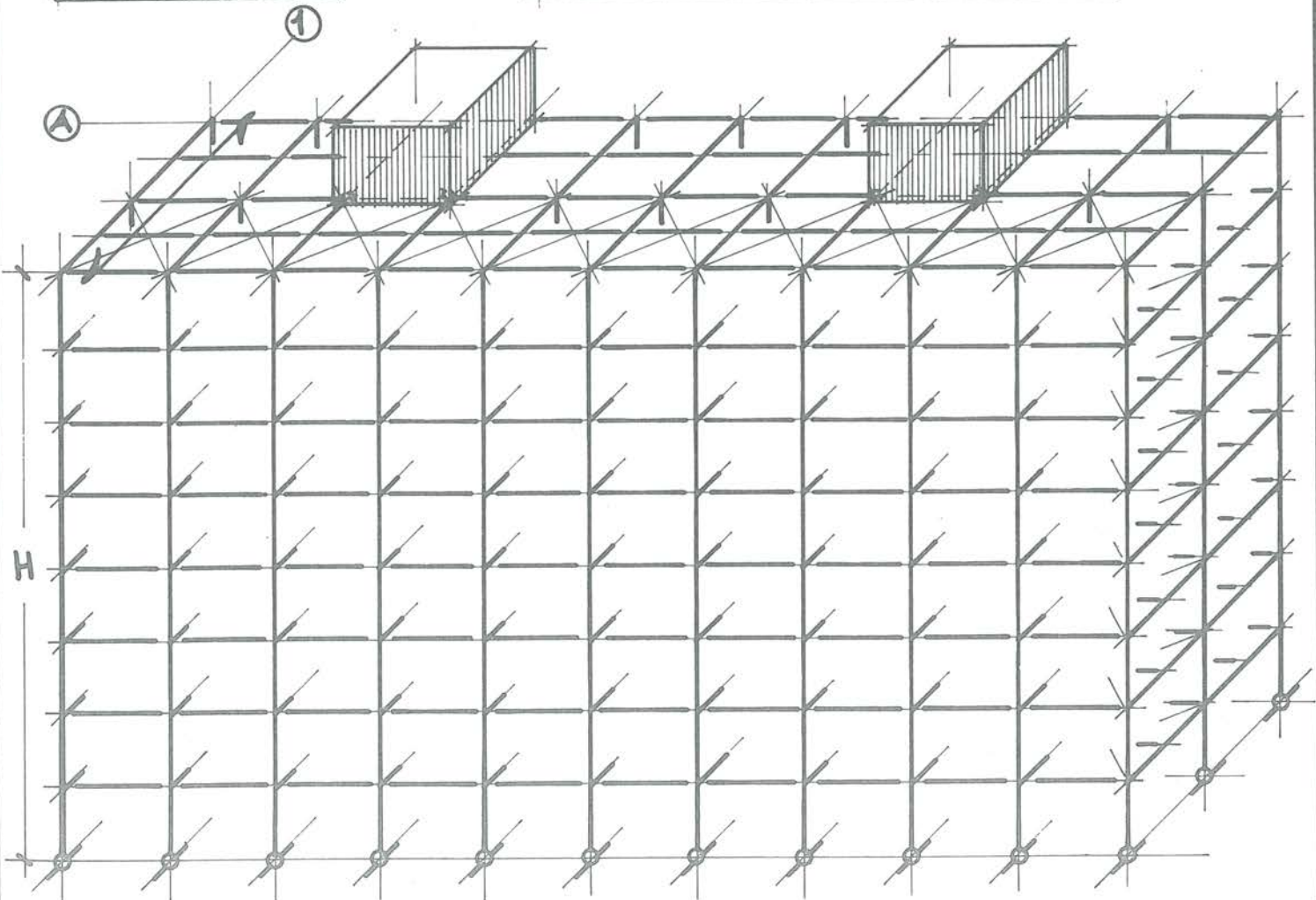

1

NUCLEO IN C.A.

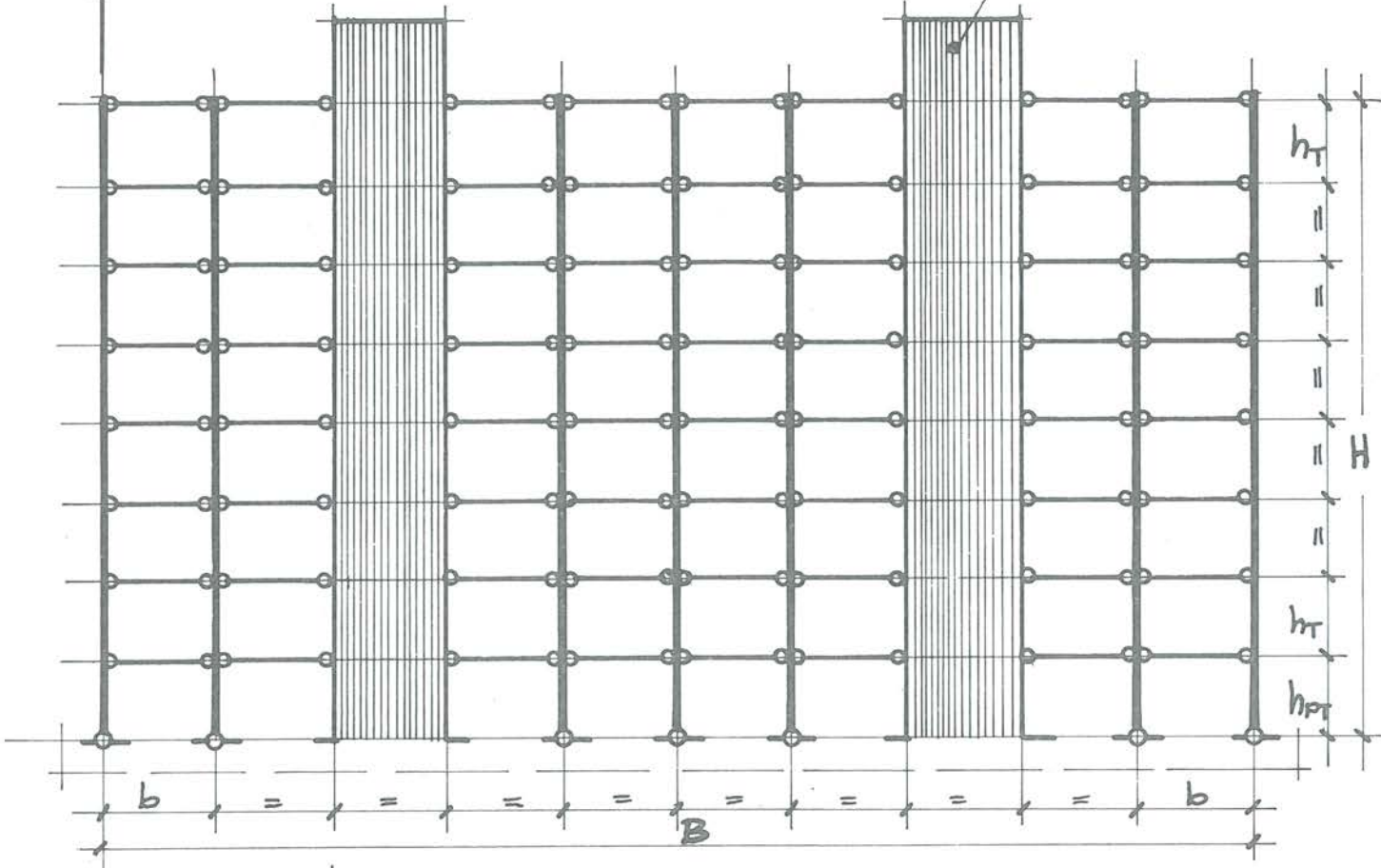

SCHEMA STRUTTURALE AI FILI "A" - "B"

11

CONTROVENTI DI PIANO

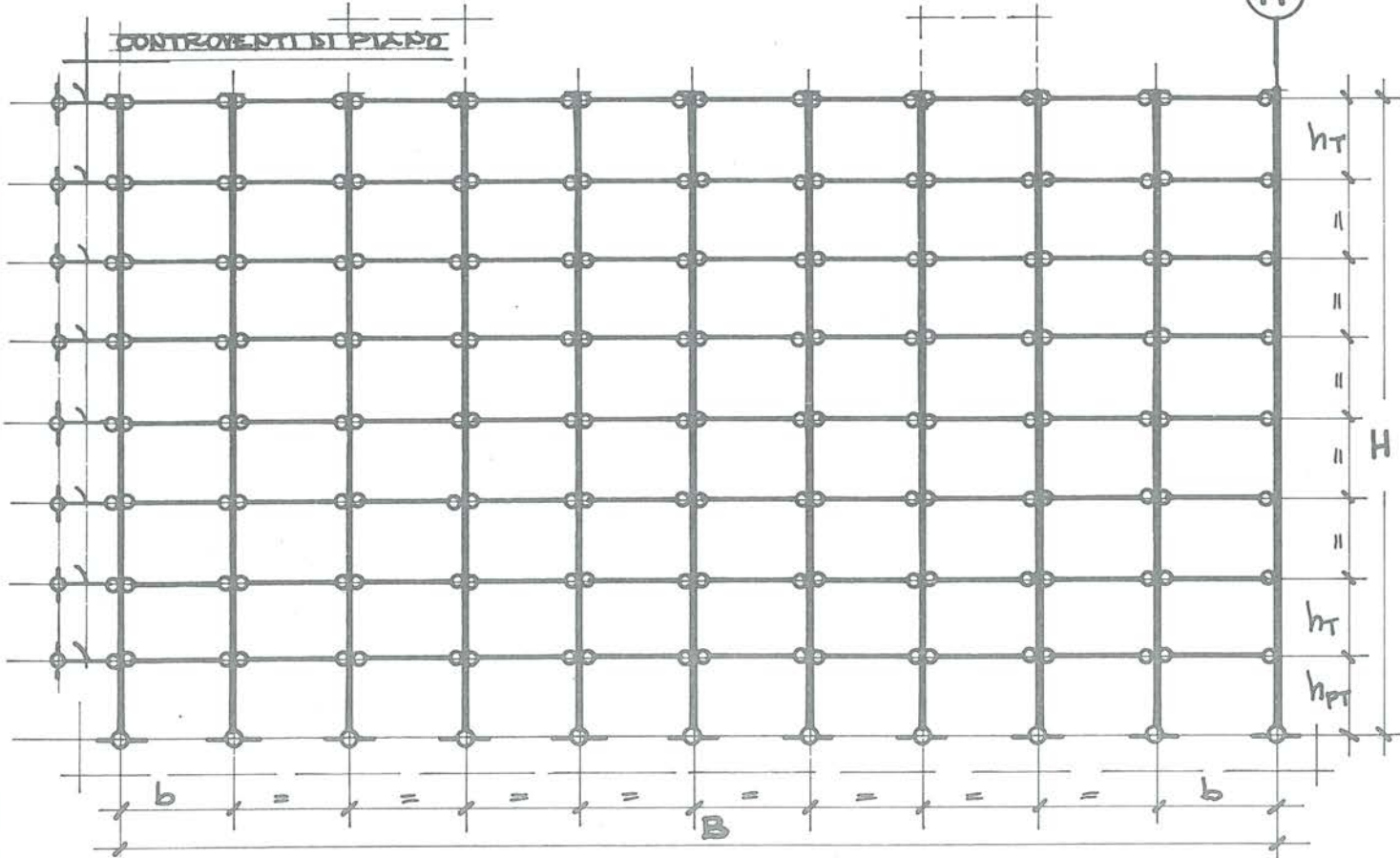

SCHEMA STRUTTURALE AL FILO "C"

SOLUZIONE β

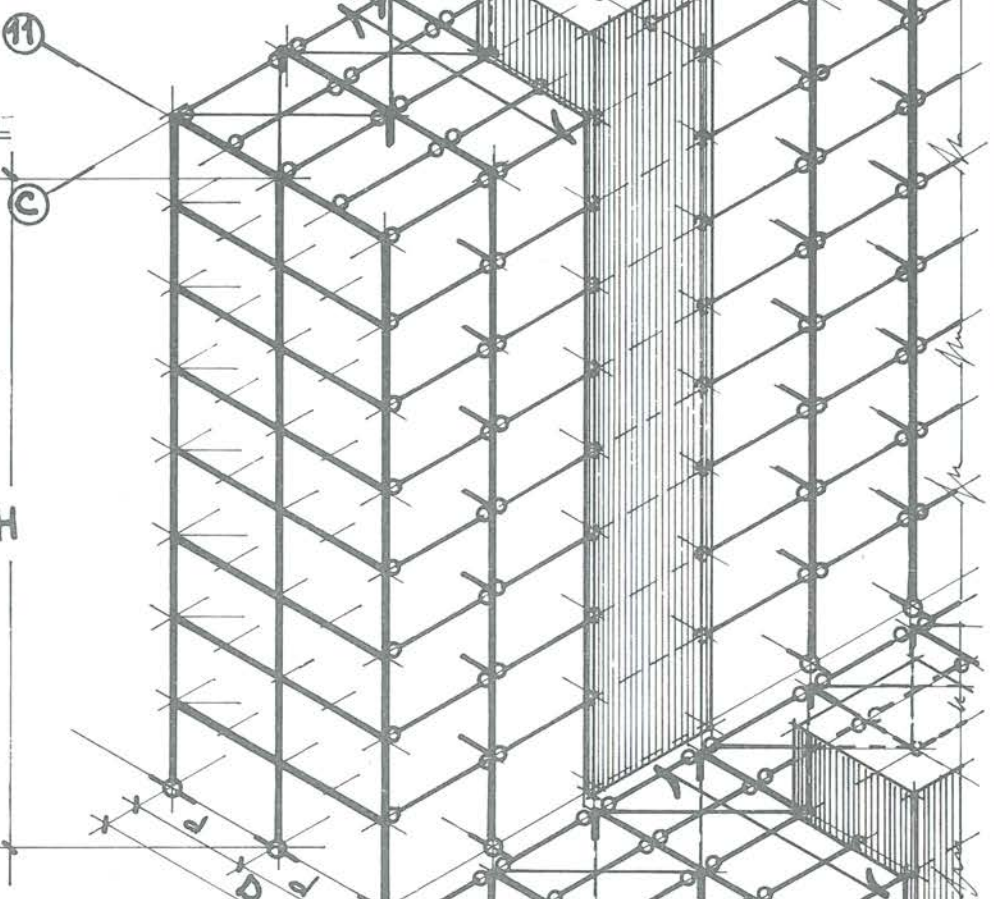
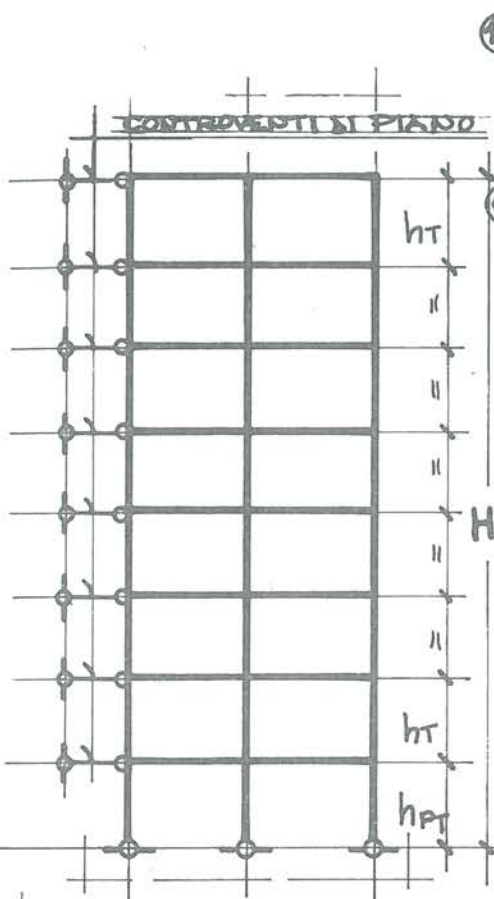

SCHEMA STRUTTURALE AI PICCHETTI
"1-2-5-6-7-10-11"

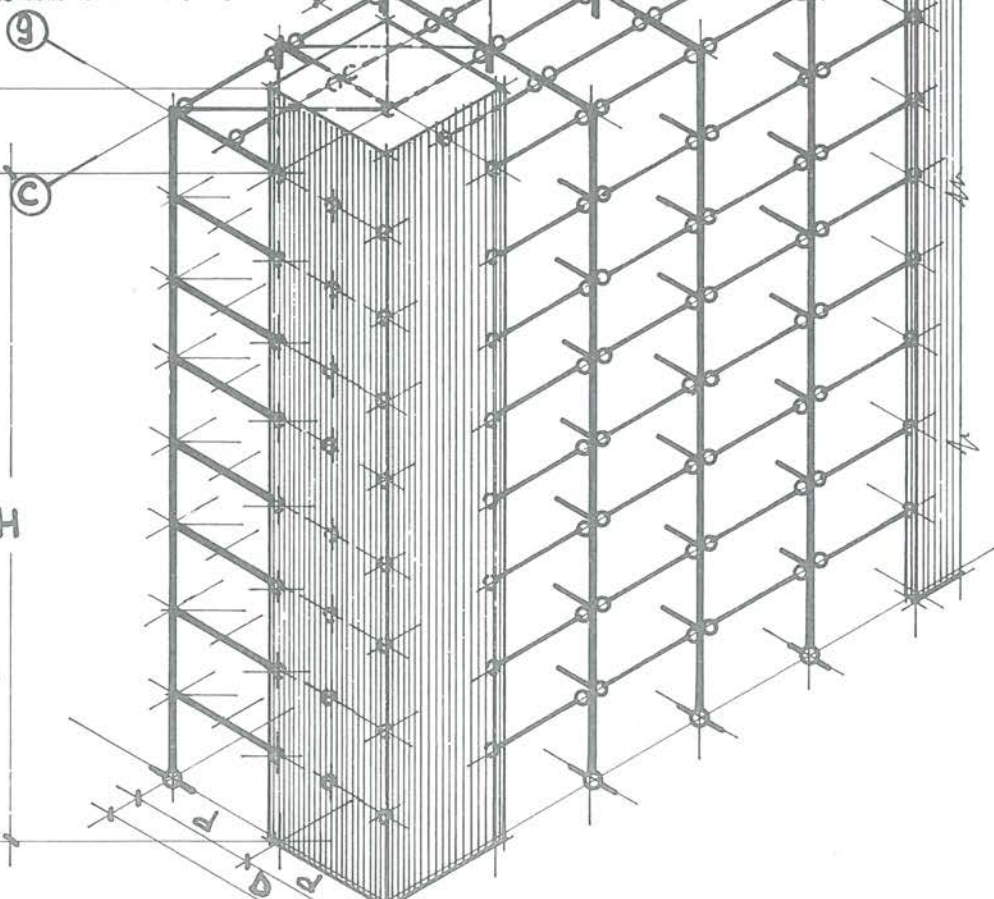
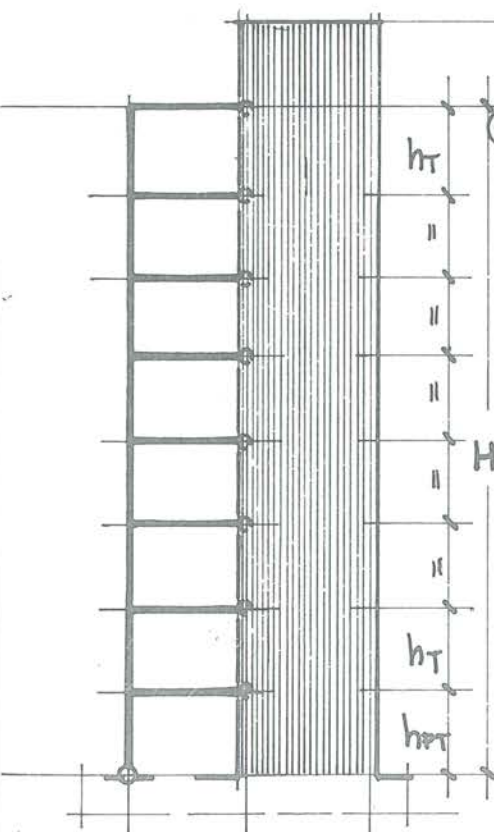

SCHEMA STRUTTURALE AI PICCHETTI
"3-4-8-9" (VALE ANCHE PER LE SOLUZIONI α E γ)

SOLUZIONE γ

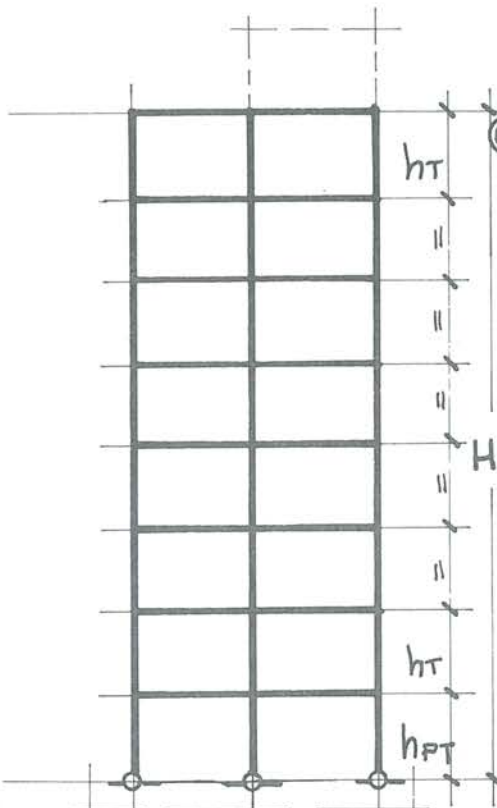

11

C

ht

H

ht

hPT

SOLUZIONE α

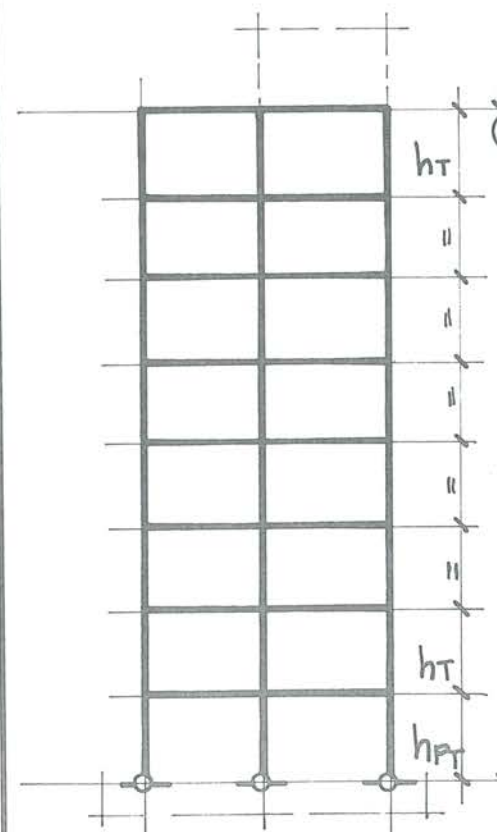

11

C

ht

H

ht

hPT

SCHEMA STRUTTURALE AI PICCHETTI
"1-2-5-6-7-10-11"

EDIFICI MULTIPIANO IN ACCIAIO CON NUCLEI IN C.A.

CONTROVENTI DI PIANO

1- SCHEMA STATICO "PENDOLARE"

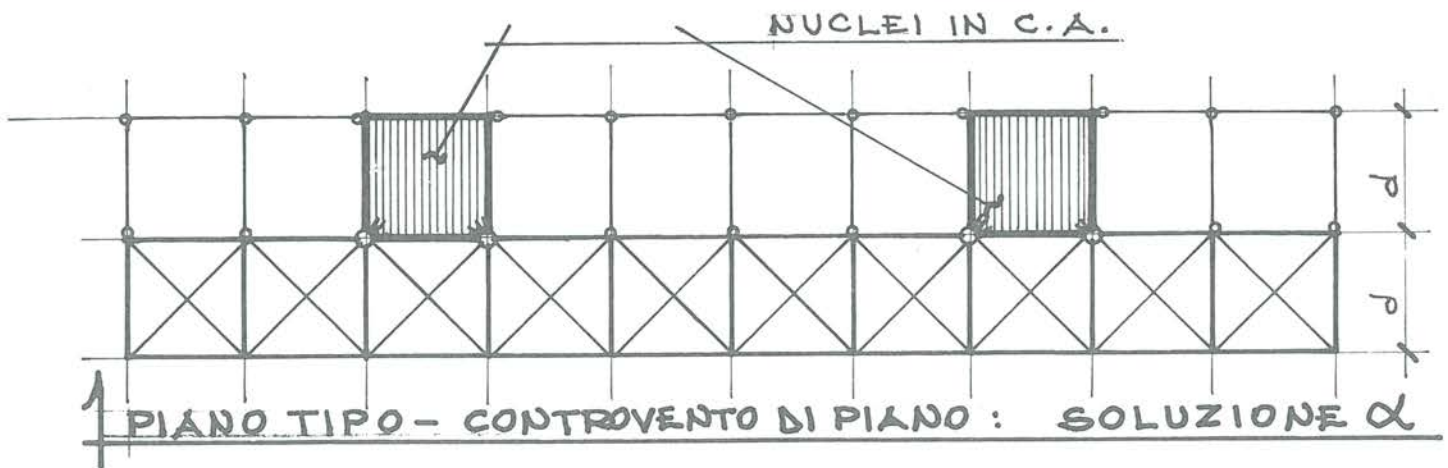

2- SCHEMA STATICO "A TELAI TRASVERSALI"

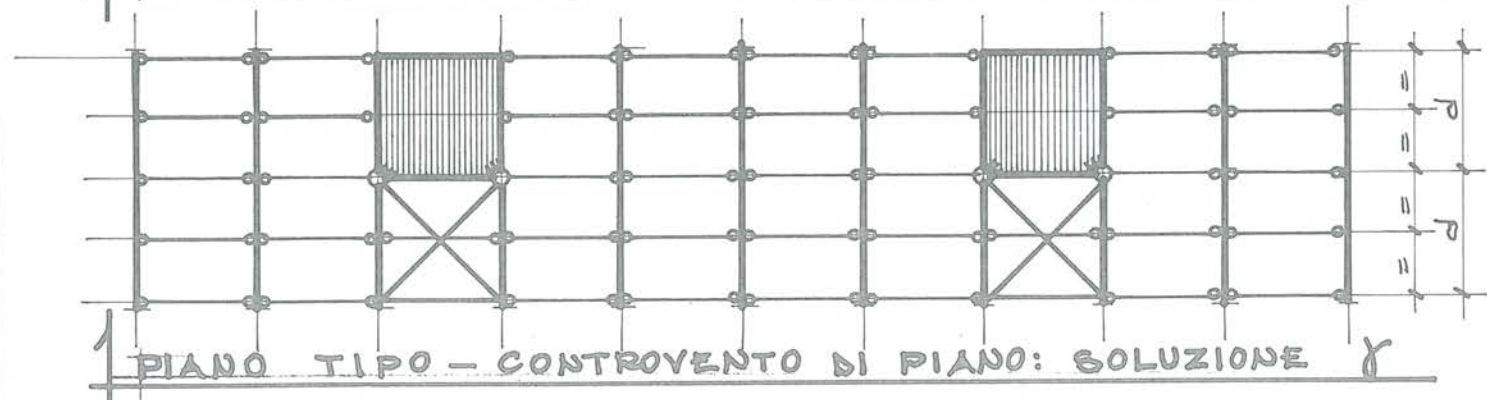
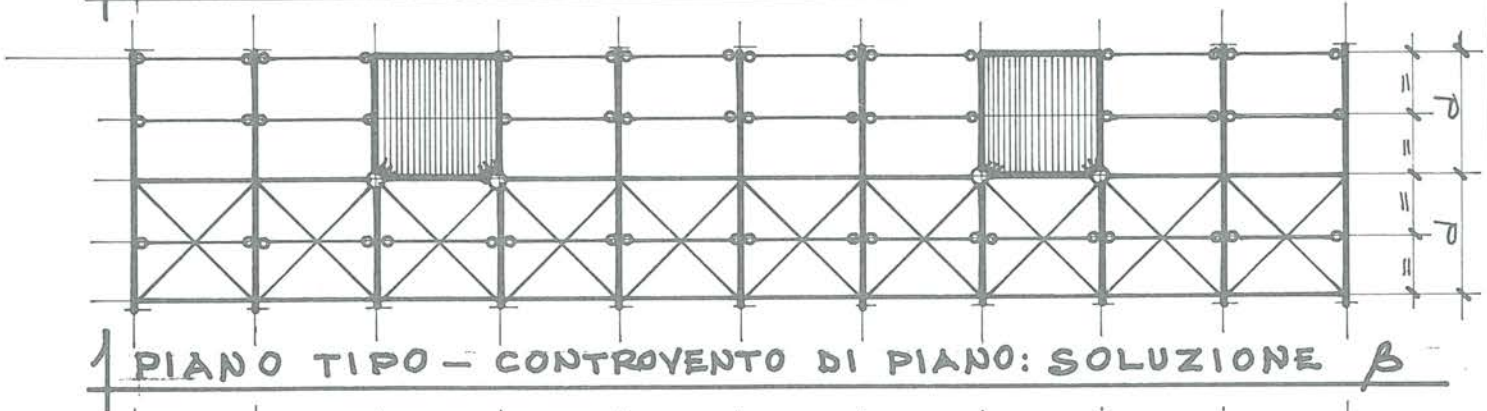

3- EDIFICIO MULTIPIANO CON STRUTTURE
 REALIZZATE TOTALMENTE IN ACCIAIO
SCHEMA STATICO "PENDOLARE"

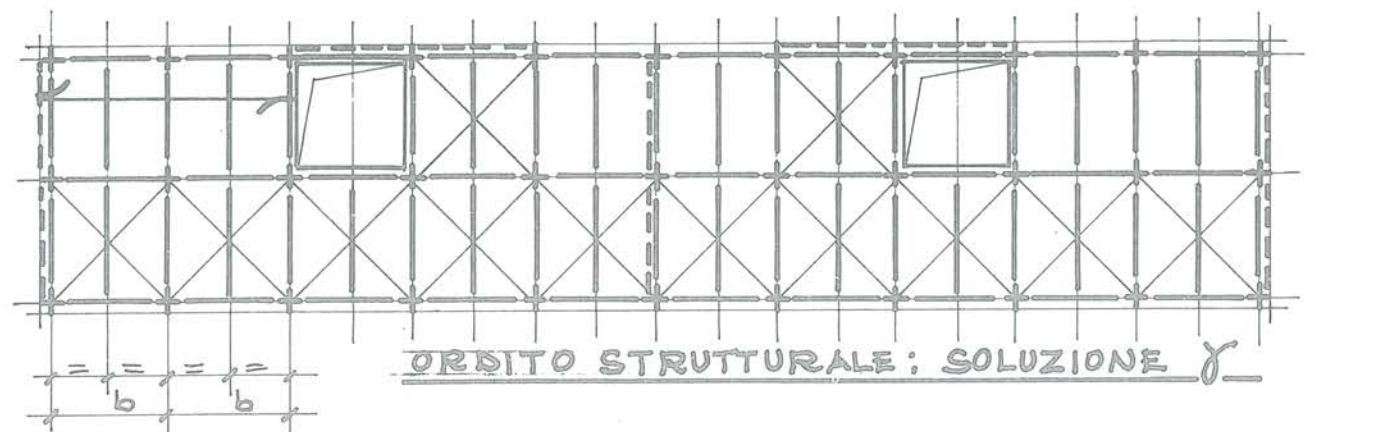
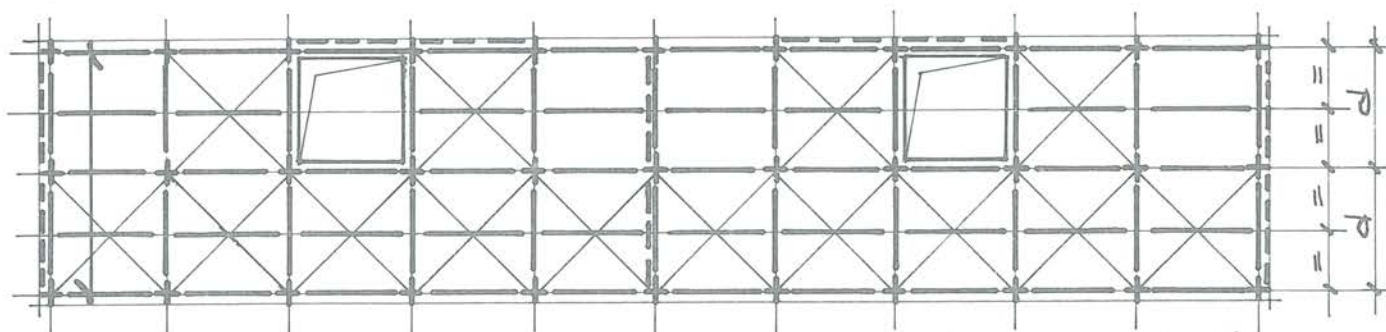
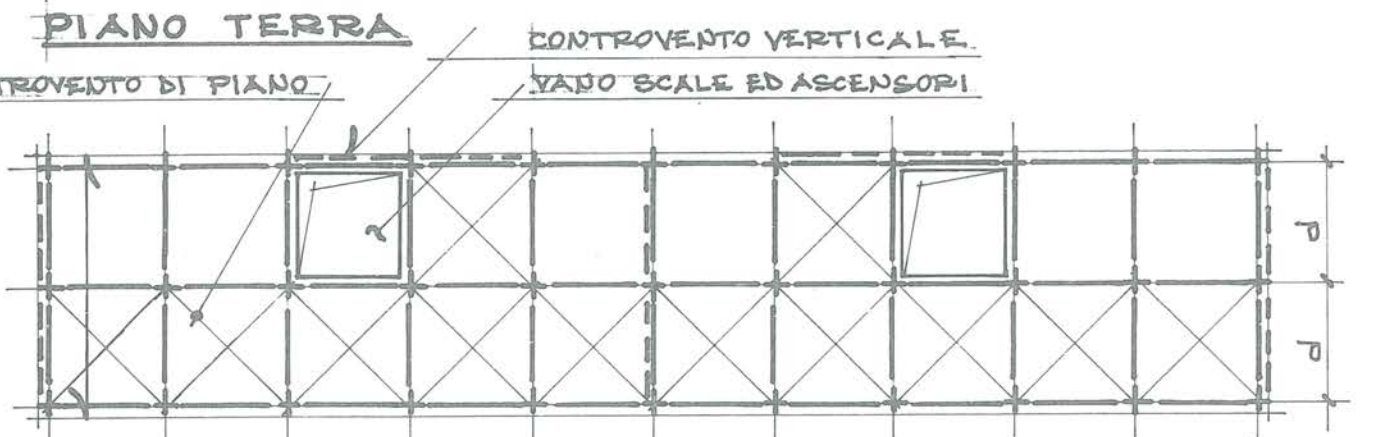
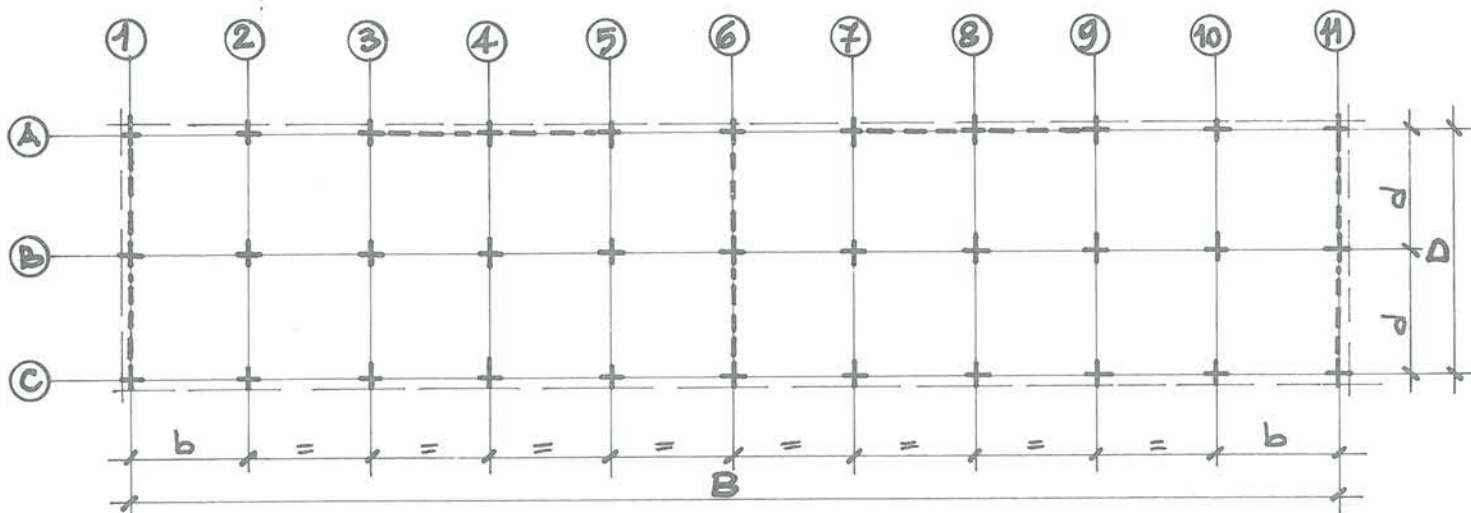

POSIZIONAMENTO DEI CONTROVENTI VERTICALI LONGITUDINALI
 ALTERNATIVE: SOLUZIONE $\alpha/2$ - SOLUZIONE $\alpha/3$

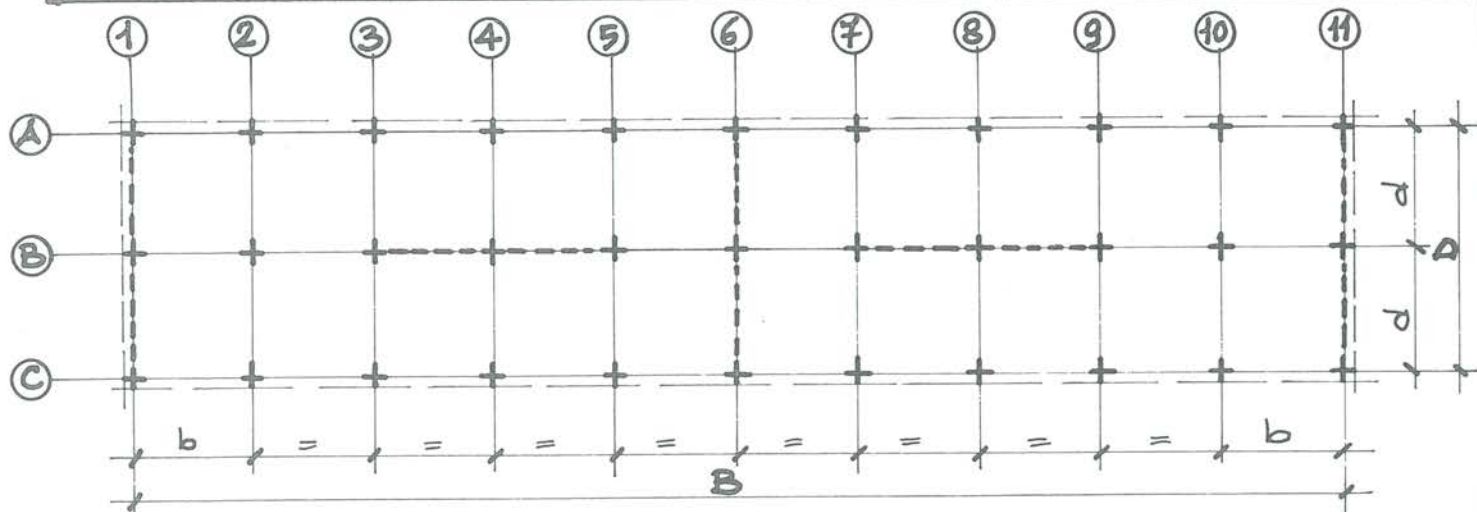

PIANO TERRA

VANO SCALE ED ASCENSORI

CONTROVENTO DI PIANO

CONTROVENTO VERTICALE

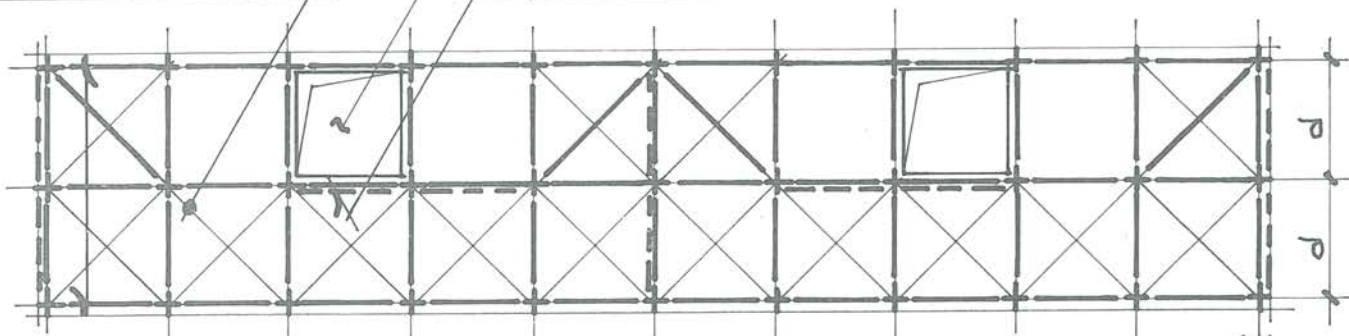

PIANO TIPO - ORDITO STRUTTURALE: SOLUZIONE $\alpha/2$

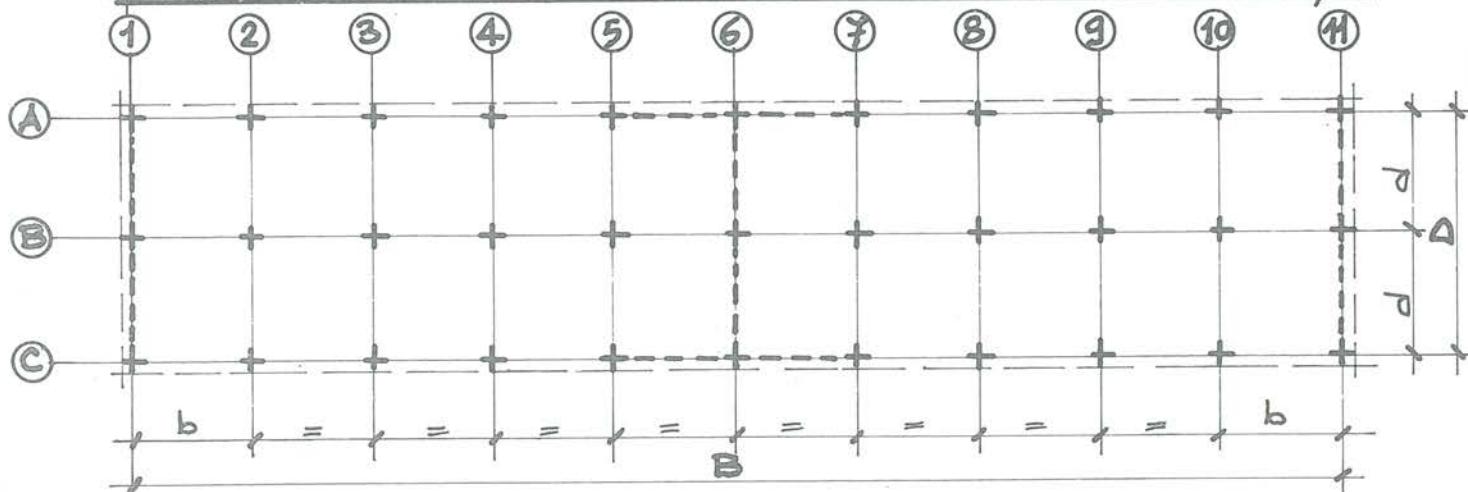

PIANO TERRA

CONTROVENTO VERTICALE

CONTROVENTO DI PIANO

VANO SCALE ED ASCENSORI

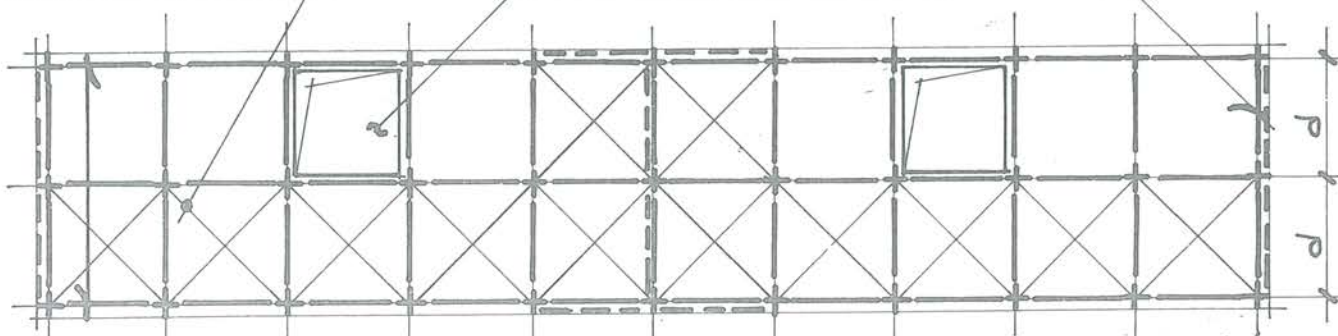

PIANO TIPO - ORDITO STRUTTURALE: SOLUZIONE $\alpha/3$

CONTROVENTI VERTICALI
VISTE ASSONOMETRICHE

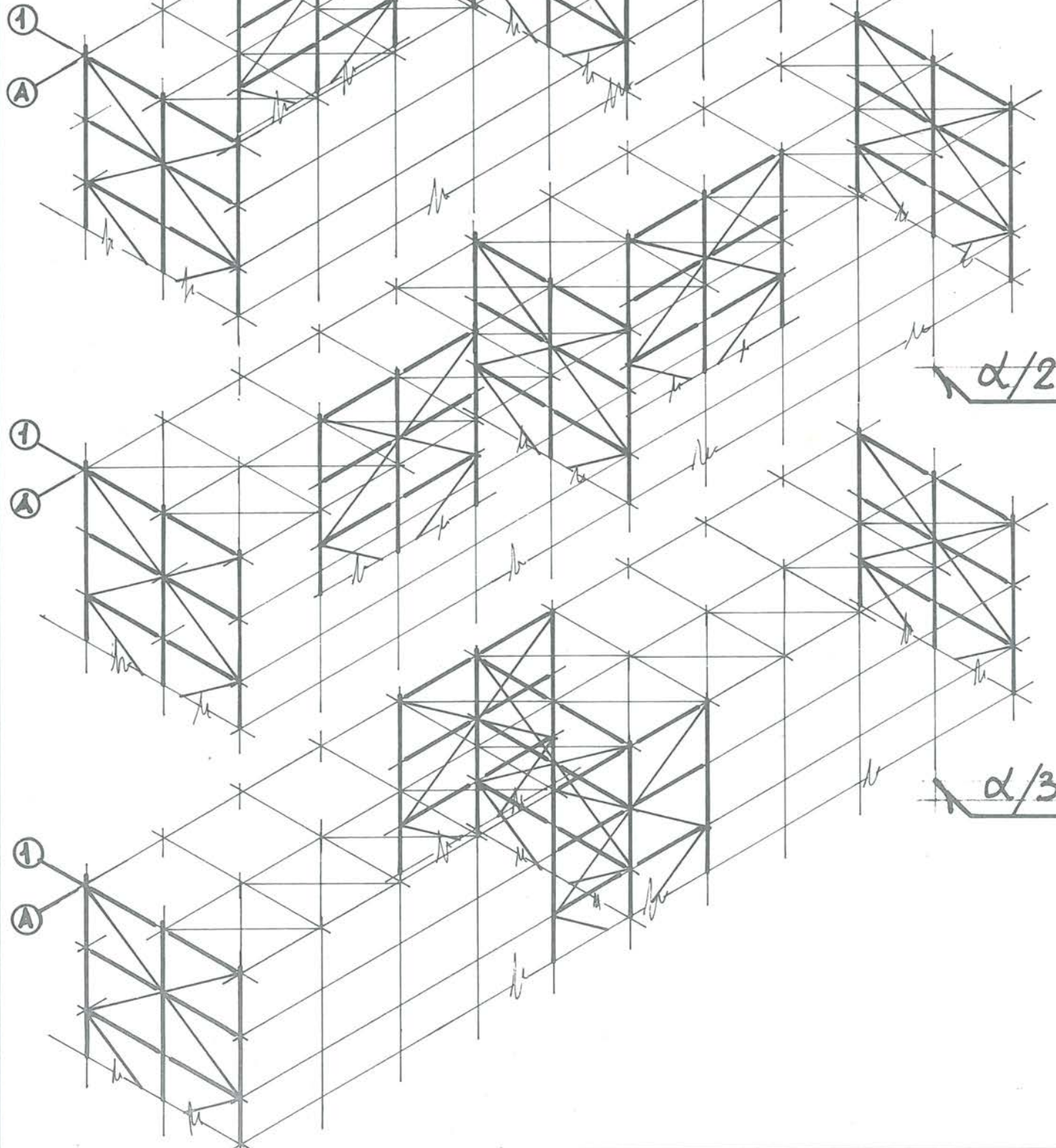

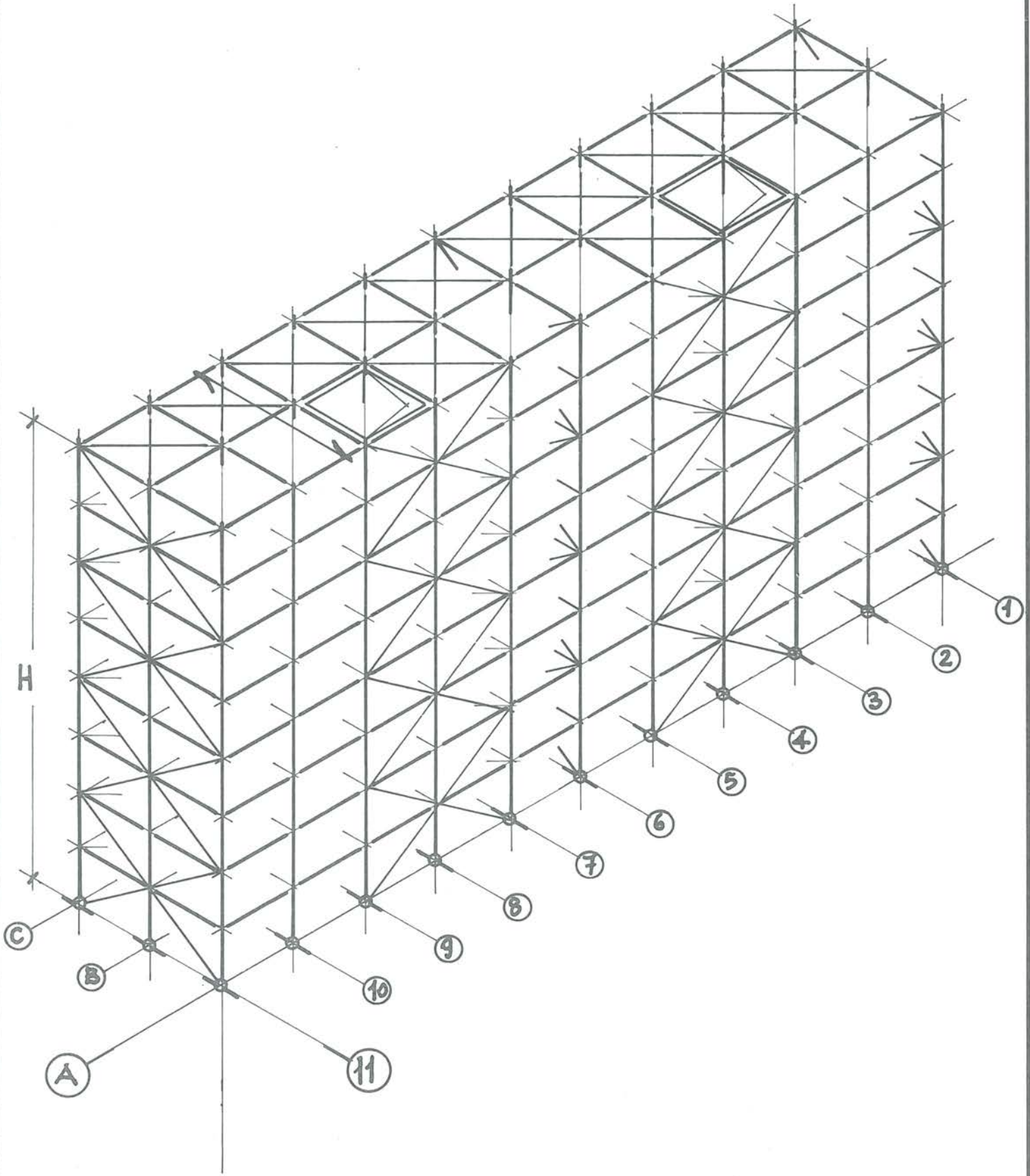

VISTA ASSONOMETRICA
SOLUZIONE $\alpha/1$

1

SOLUZIONE $\alpha/1$

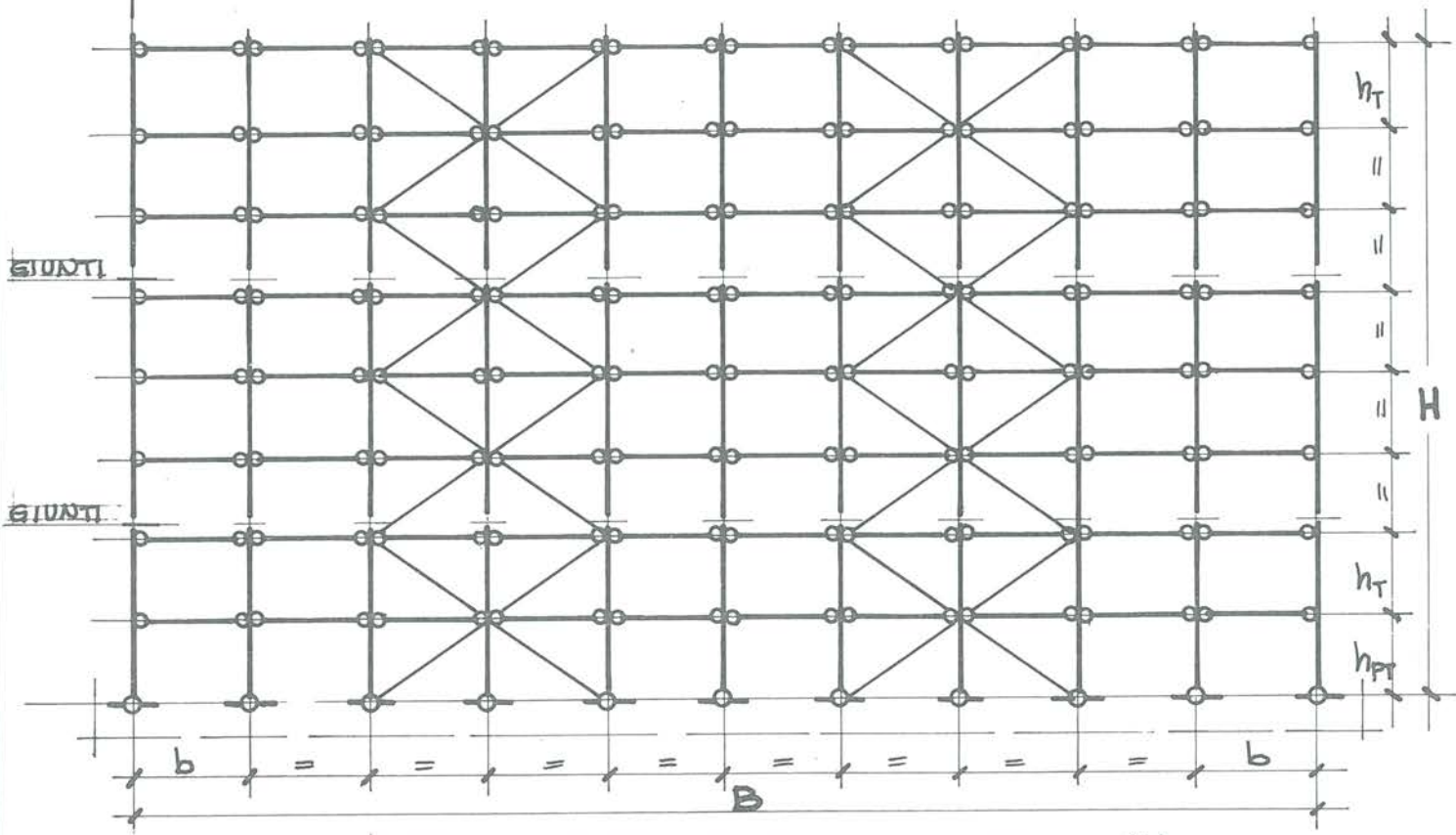

SCHEMA STRUTTURALE AL FILO "A"

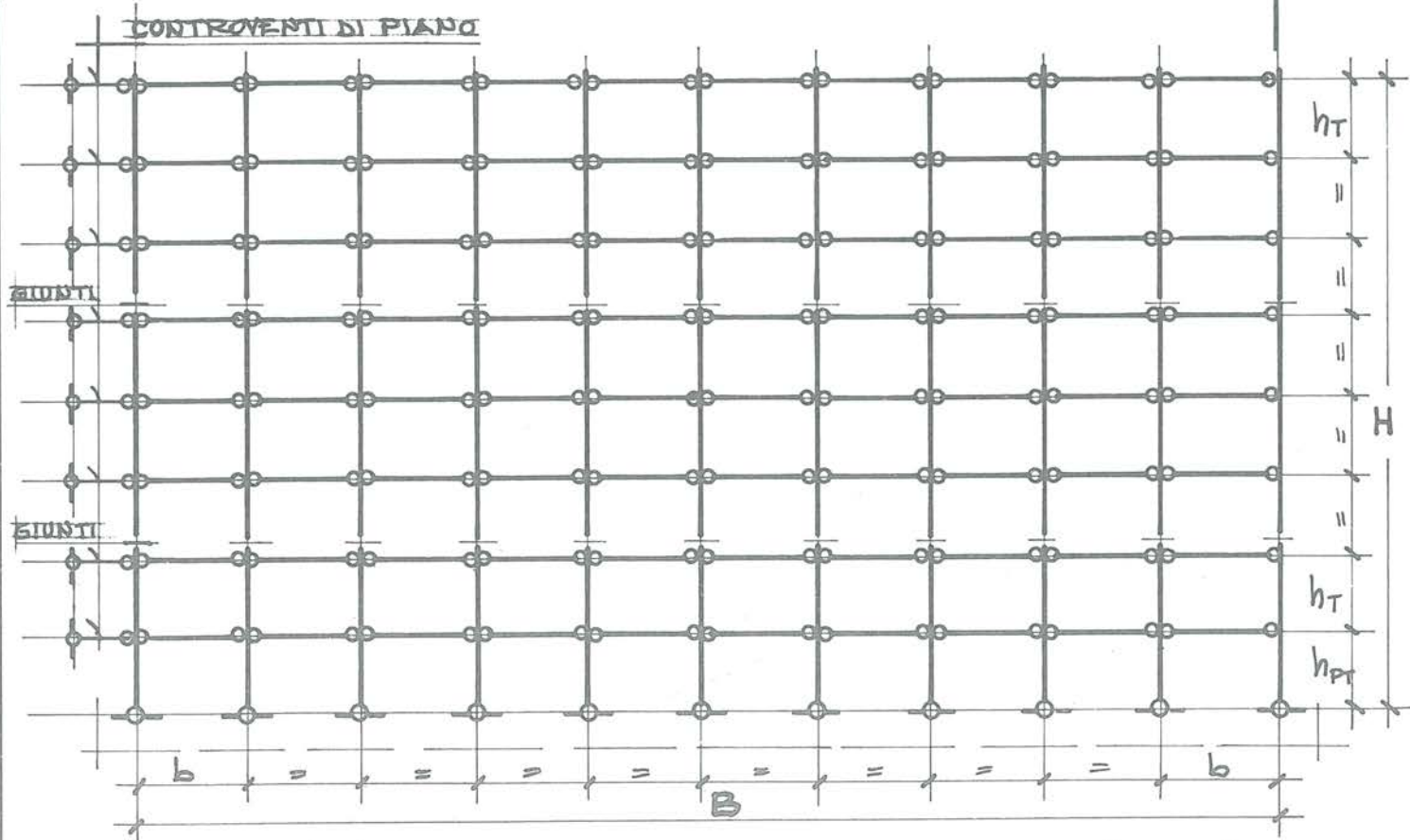

SCHEMA STRUTTURALE AL FILI "B" - "C"

SOLUZIONE $\alpha/1$

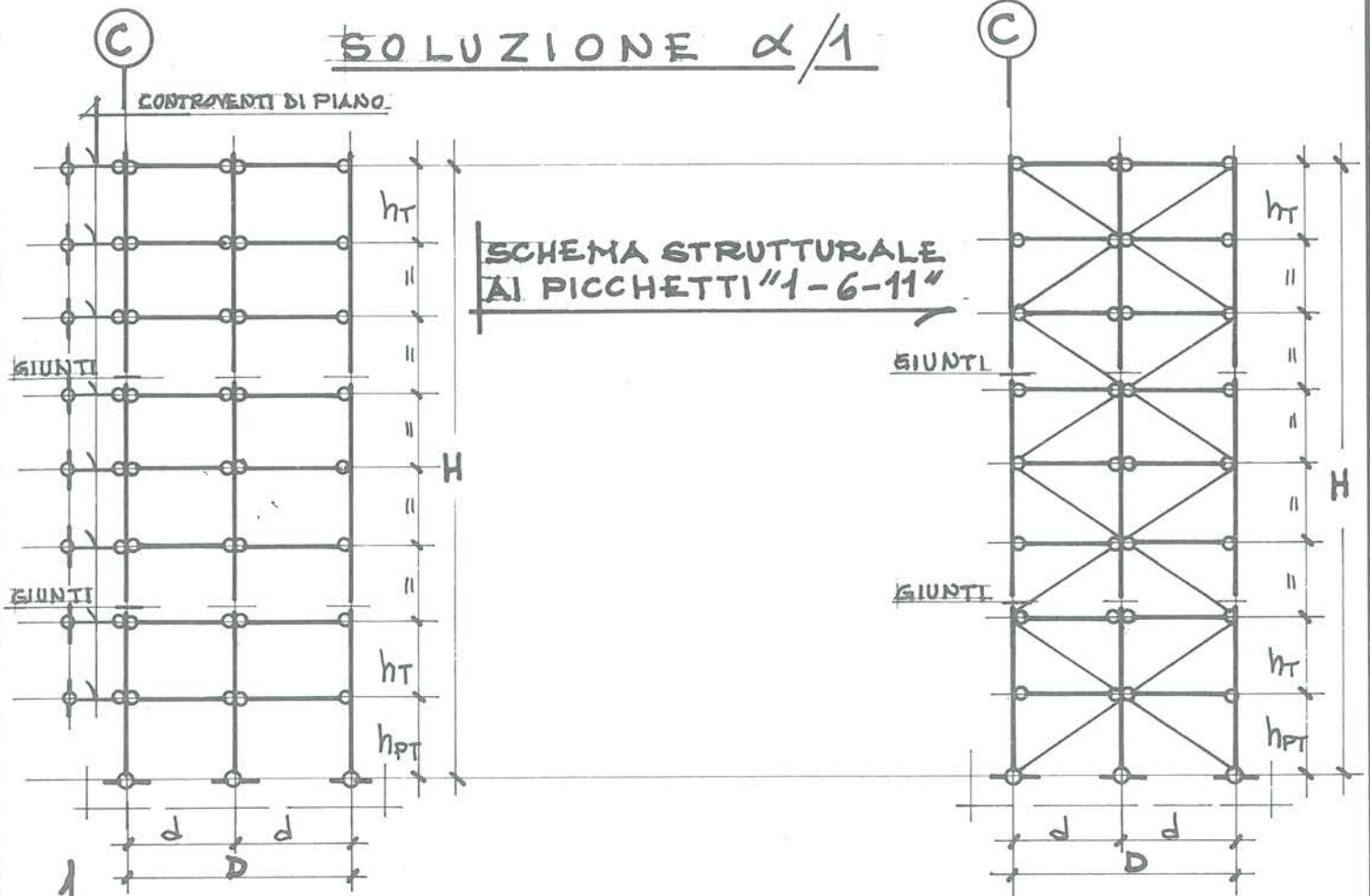

SCHEMA STRUTTURALE AI PICCHETTI "2-3-4-5-7-8-9-10"

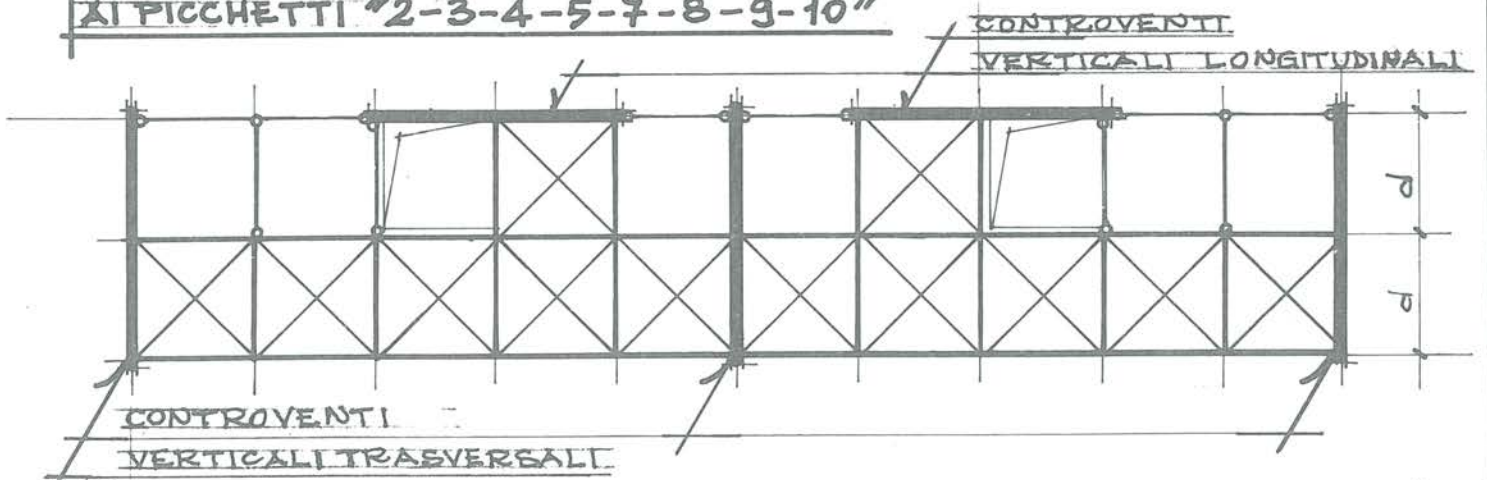

PIANO TIPO - CONTRORVENTO DI PIANO: SOLUZIONE $\alpha/1$

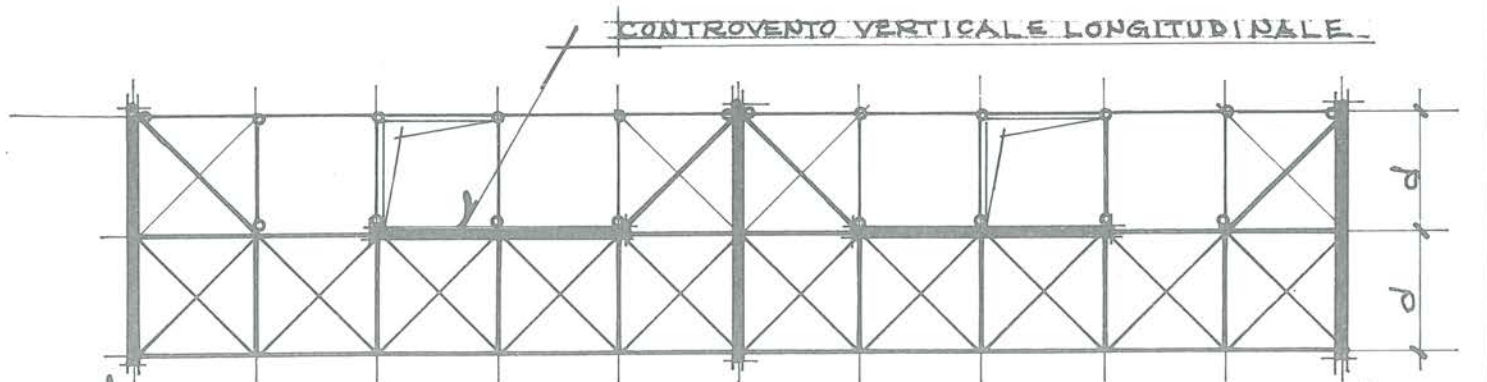

PIANO TIPO - CONTRORVENTO DI PIANO: SOLUZIONE $\alpha/2$

4- EDIFICIO MULTIPIANO CON STRUTTURE
REALIZZATE TOTALMENTE IN ACCIAIO

SCHEMA STATICO "A TELAI TRASVERSALI"

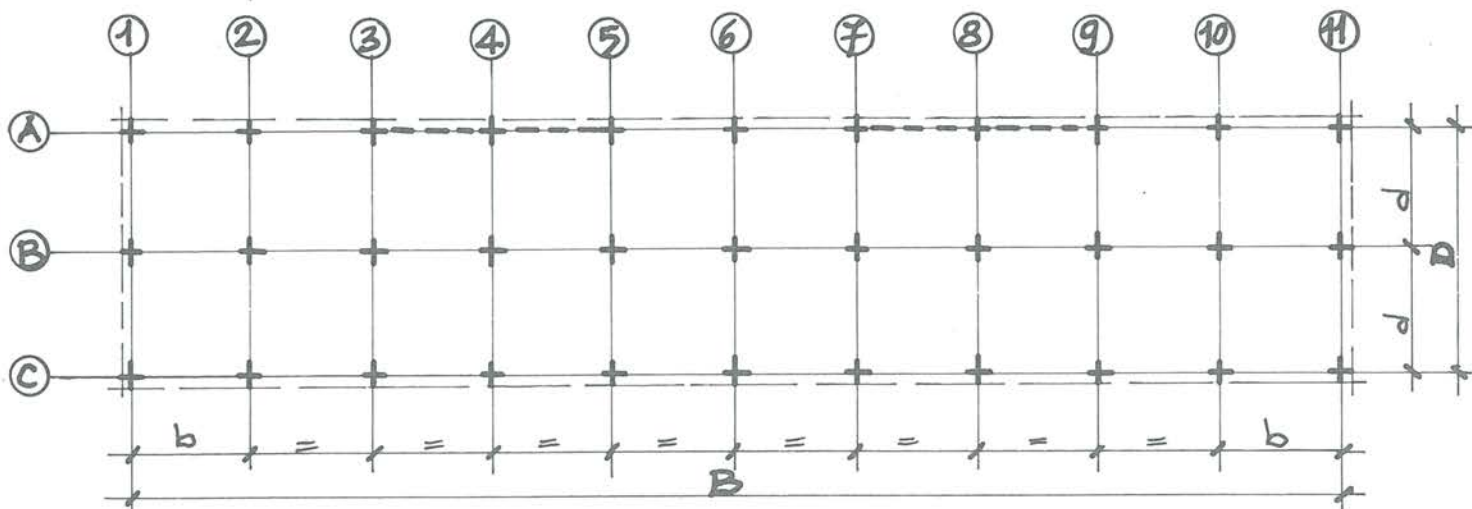

PIANO TERRA

CONTROVENTI VERTICALI LONGITUDINALI

CONTROVENTO DI PIANO

NANO SCALE ED ASCENSORI

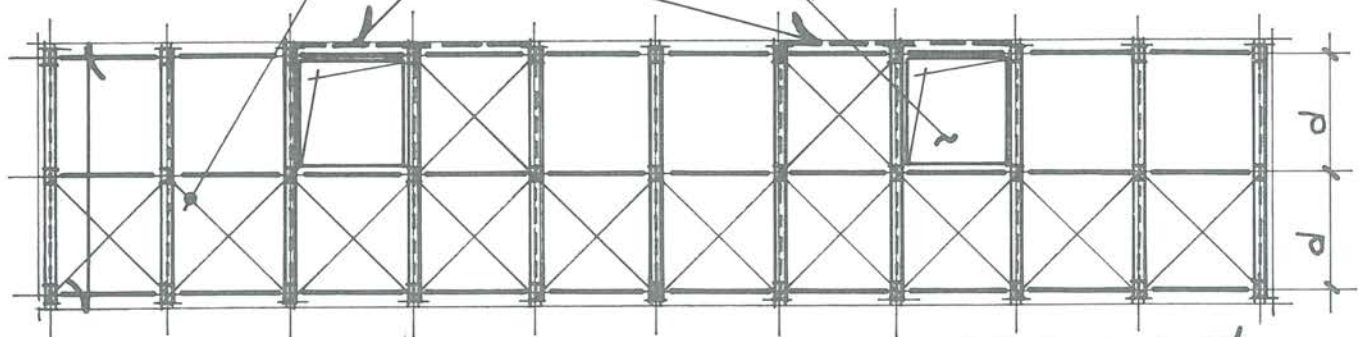

PIANO TIPO - ORDITO STRUTTURALE: SOLUZIONE α

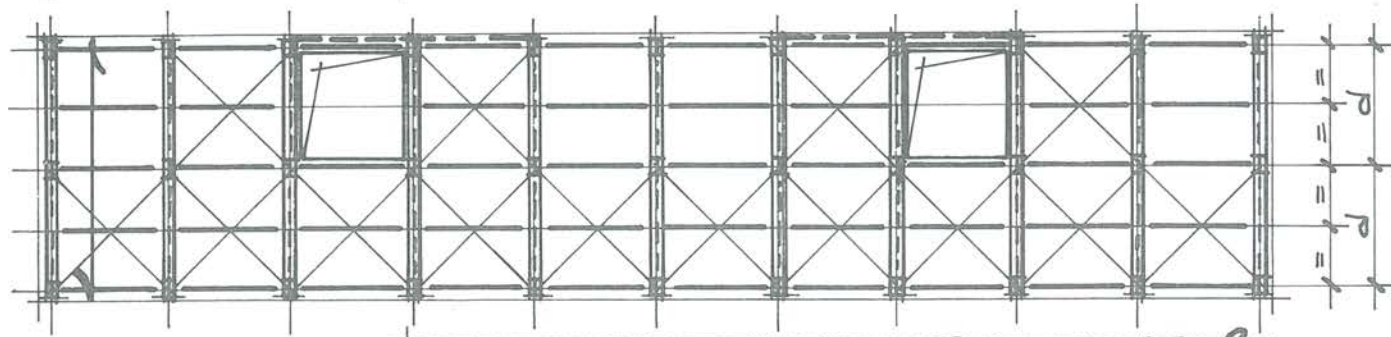

ORDITO STRUTTURALE: SOLUZIONE β

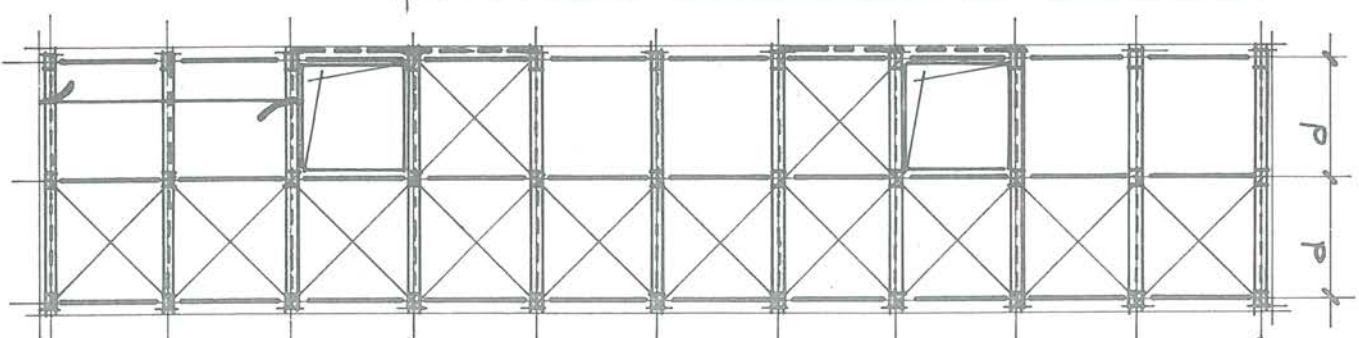

ORDITO STRUTTURALE: SOLUZIONE $\delta/1$

POSIZIONAMENTO DEI CONTROVENTI VERTICALI LONGITUDINALI
ALTERNATIVE: SOLUZIONE $\delta/2$ = SOLUZIONE $\delta/3$

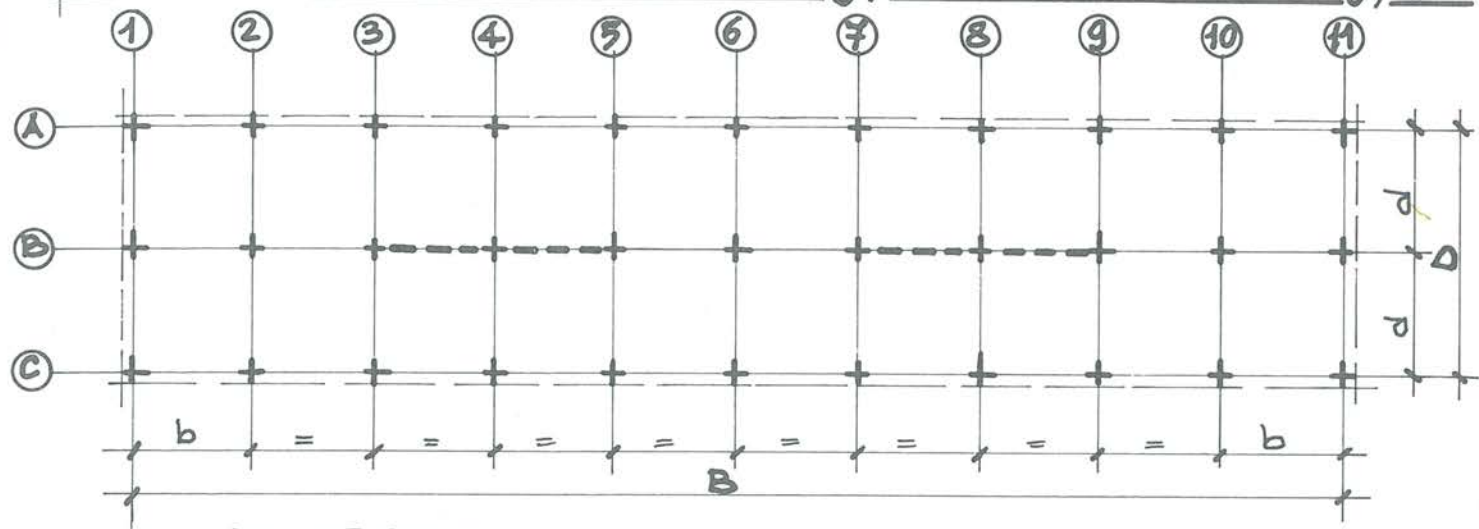

PIANO TERRA

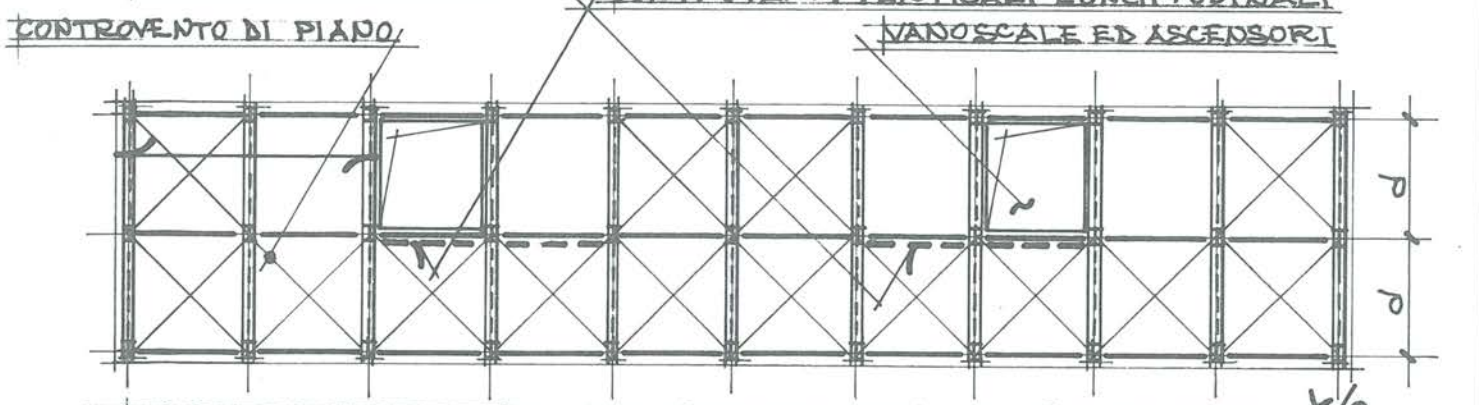

PIANO TIPO - ORBITO STRUTTURALE: SOLUZIONE $\delta/2$

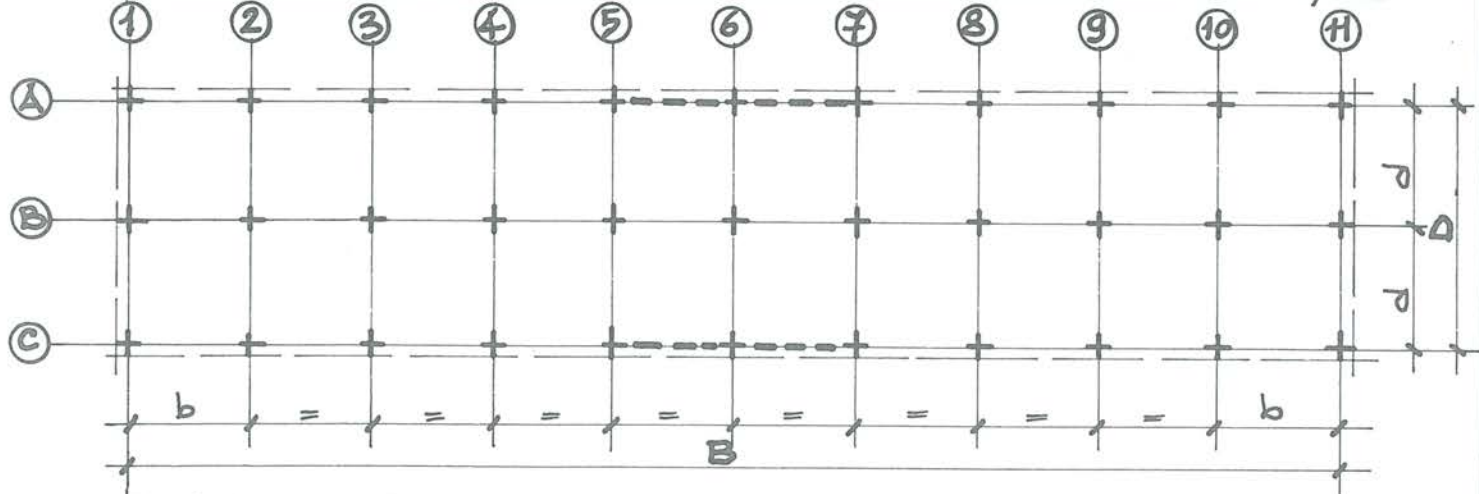

PIANO TERRA

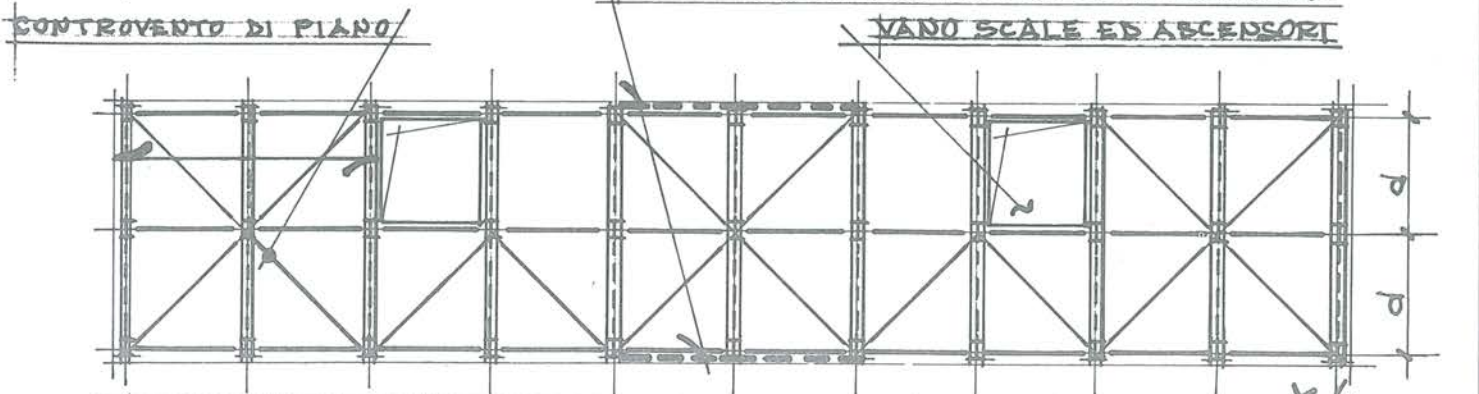

PIANO TIPO - ORBITO STRUTTURALE: SOLUZIONE $\delta/3$

CONTROVENTI VERTICALI LONGITUDINALI
VISTE ASSONOMETRICHE

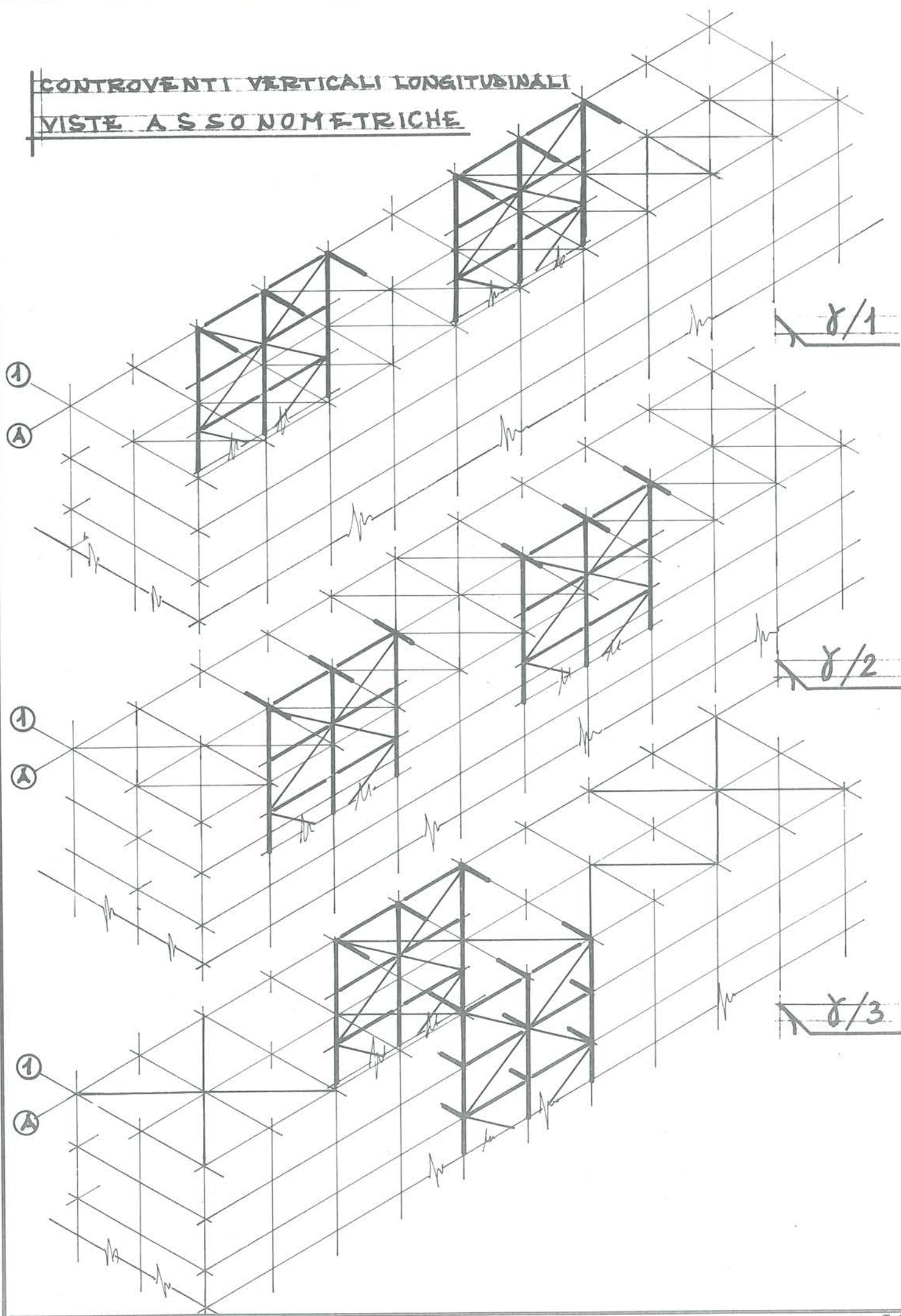

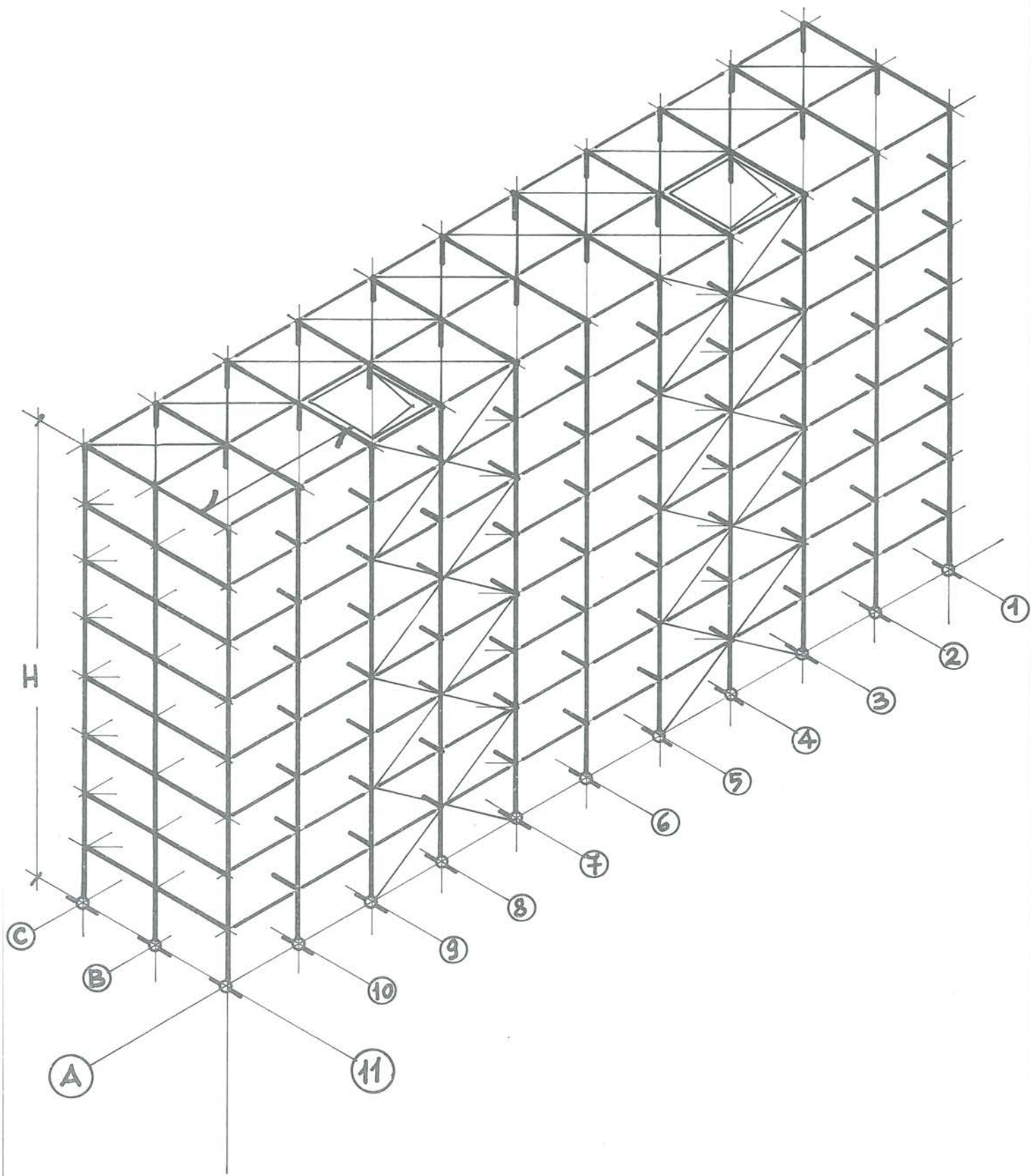

VISTA ASSONOMETRICA
SOLUZIONE 8/1

1

SOLUZIONE 8/A

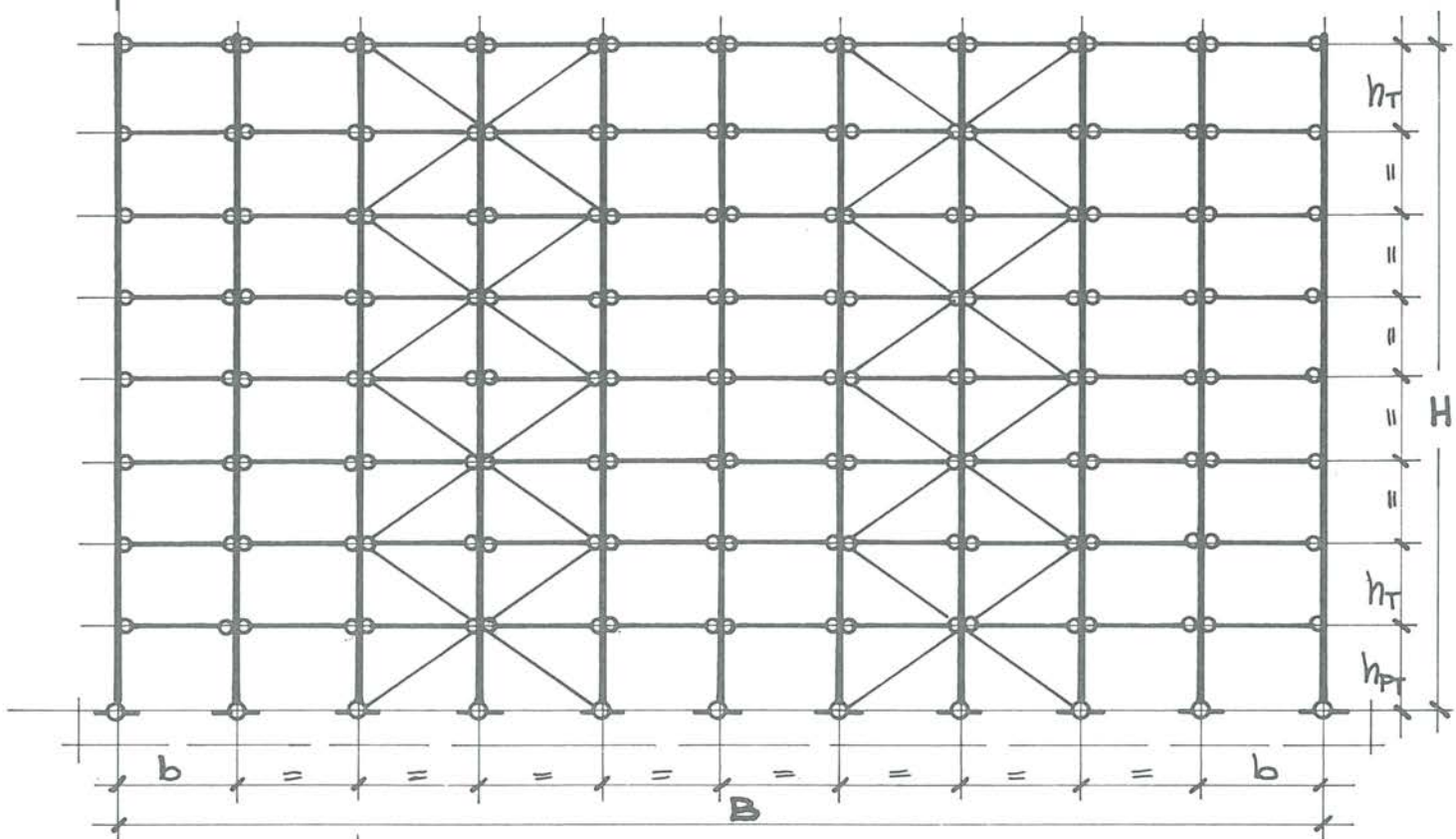

SCHEMA STRUTTURALE AL FILO "A"

11

CONTROVENTI IN PIANO

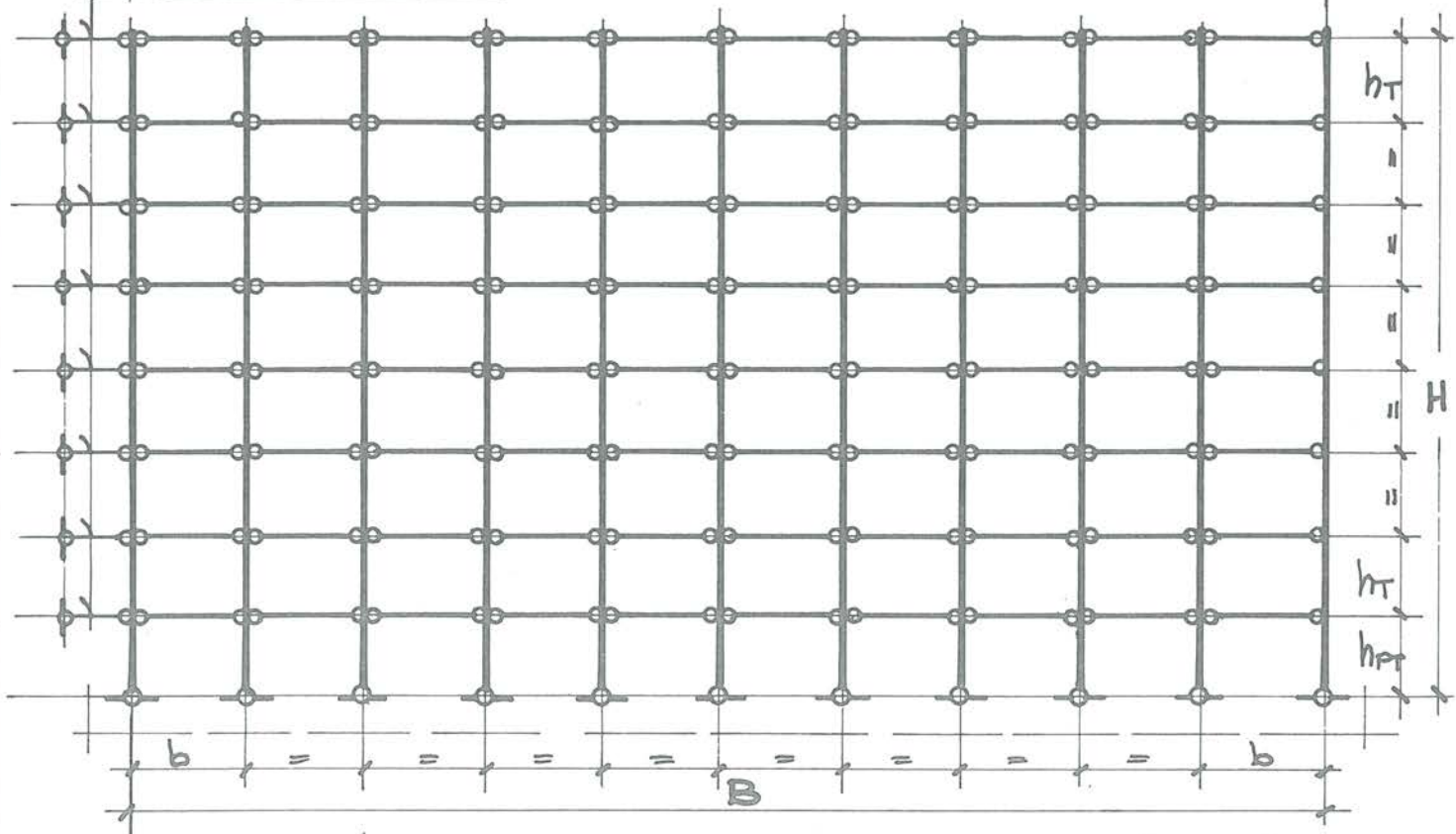

SCHEMA STRUTTURALE AI FILI "B" - "C"

(C)

SOLUZIONE $\delta/1$

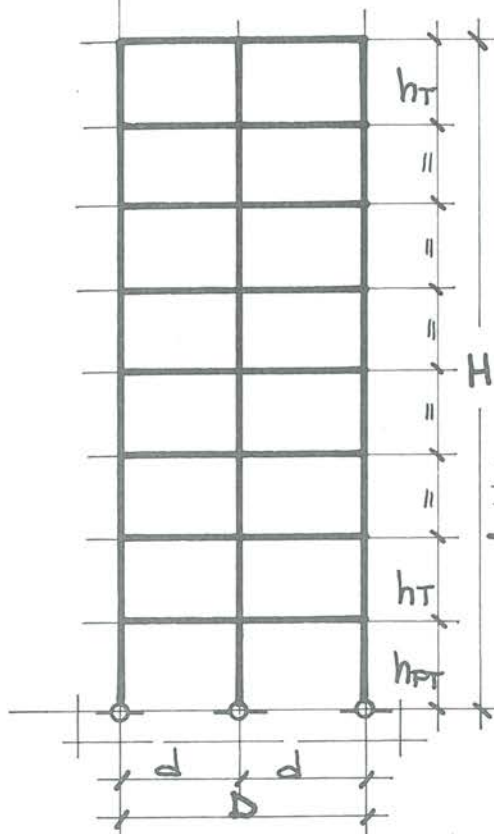

SCHEMA STRUTTURALE
AI PICCHETTI "1-2-3-4-5-6-7-8-9-10-11"

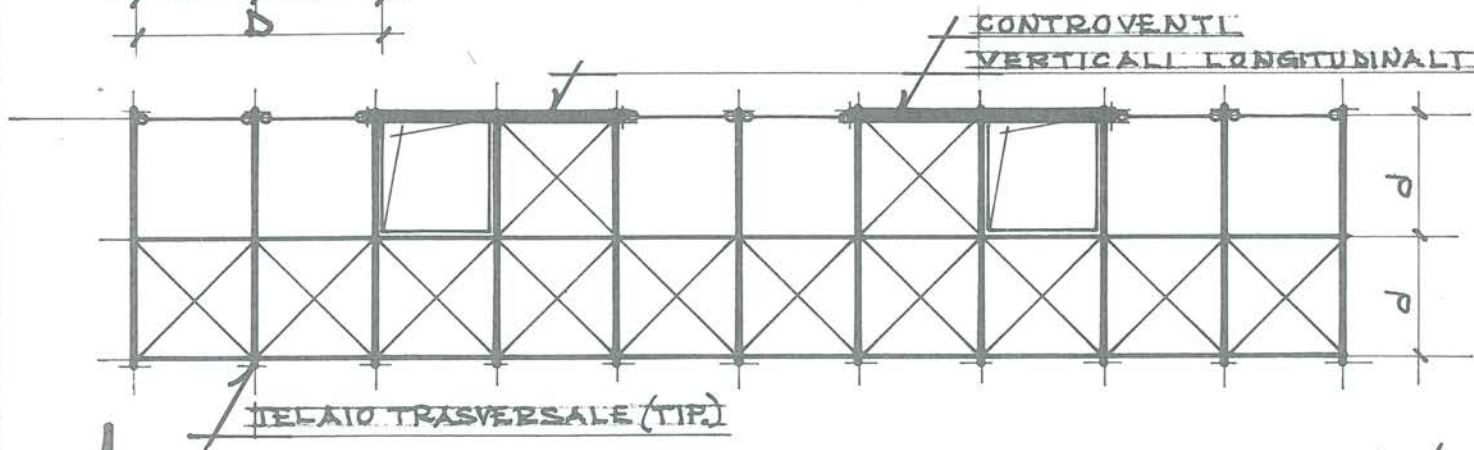

PIANO TIPO - CONTROVENTO DI PIANO: SOLUZIONE $\delta/1$

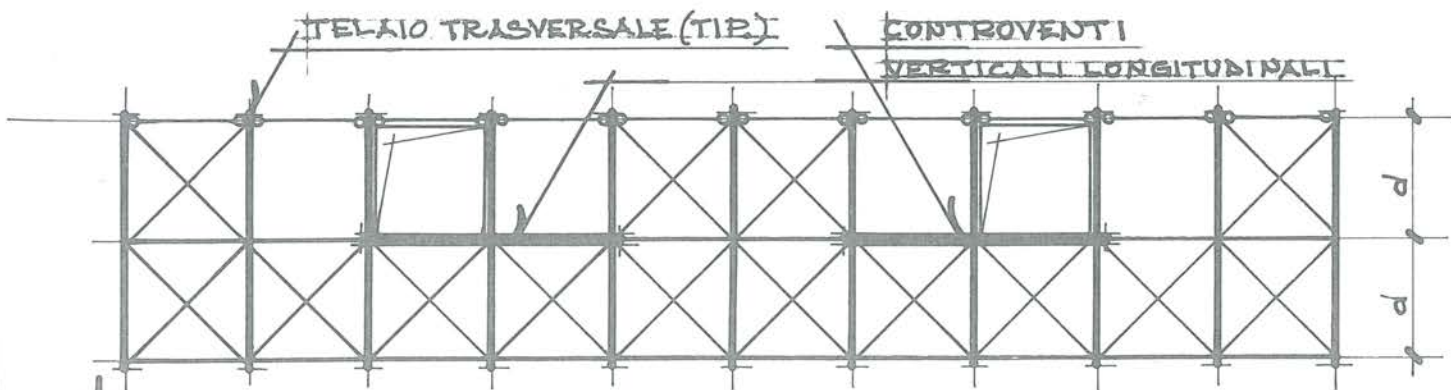

PIANO TIPO - CONTROVENTO DI PIANO: SOLUZIONE $\delta/2$

CONTROVENTI VERTICALI RETICOLARI PER EDIFICI CIVILI

AL FINE DI INDIRIZZARE IL PROGETTISTA
NELL'IMPOSTAZIONE DEGLI SCHEMI STRUTTURALI
DEI CONTROVENTI, SONO DI SEGUITO RIPORTATE
ALCUNE TIPOLOGIE DI CONTROVENTI VERTICALI
RETICOLARI PER EDIFICI CIVILI.

CONTROVENTI VERTICALI RETICOLARI
CON DIAGONALI A CROCE DI SANT'ANDREA
(DIAGONALI TENSE)

-EDIFICI CIVILI-

1 - DIAGONALE E CONTRODIAGONALE SU UN PIANO
(DISPOSTE IN UNA CAMPATA)

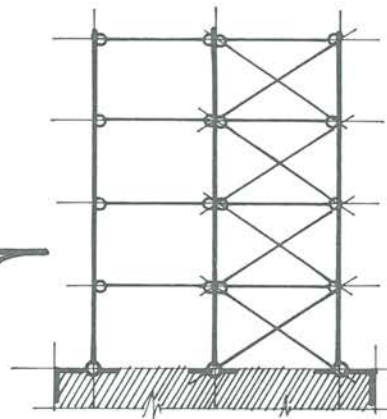

2 - DIAGONALE E CONTRODIAGONALE SU DUE PIANI
(DISPOSTE IN DUE CAMPATE)

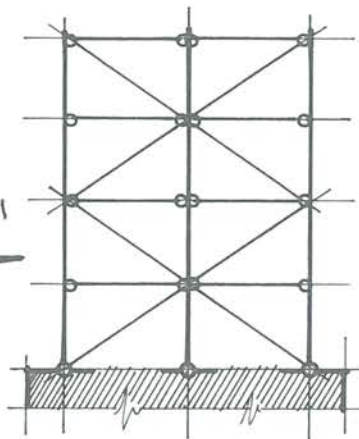

3 - DUE COPPIE DI DIAGONALE E CONTRODIAGONALE
DISPOSTE SU UN PIANO (IN DUE CAMPATE)

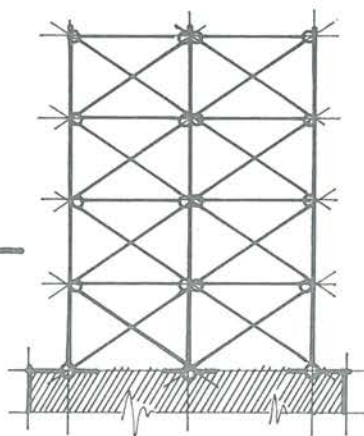

CONTROVENTI VERTICALI RETICOLARI
 CON DIAGONALI A CROCE DI SANT'ANDREA
 IMPOSTATI SU UNA STRUTTURA RETICOLARE
 A NODI RIGIDI VINCOLATA ALLE FONDAZIONI
 E AVENTE "SCHEMA A K CON TRAVERSO
 INFERIORE IN ACCIAIO"

(DIAGONALI TESE)
 (DIAGONALI COMPRESSE E TESE)

- EDIFICI CIVILI -

4 - DIAGONALE E CONTRODIAGONALE
 SU DUE PIANI
 (DISPOSTE IN DUE CAMPATE)

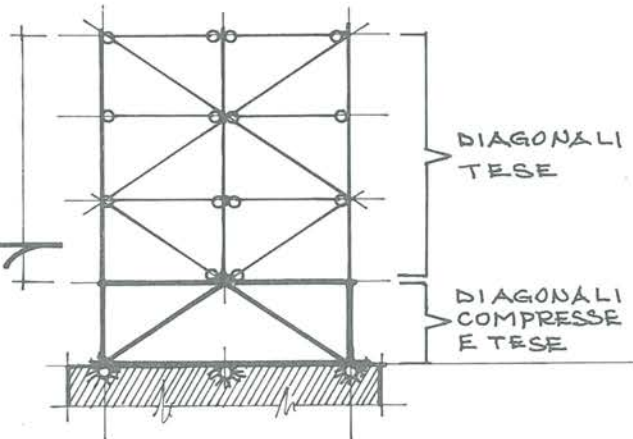

5 - DUE COPPIE DI DIAGONALE E CONTRODIAGONALE
 DISPOSTE SU UN PIANO
 (IN DUE CAMPATE)

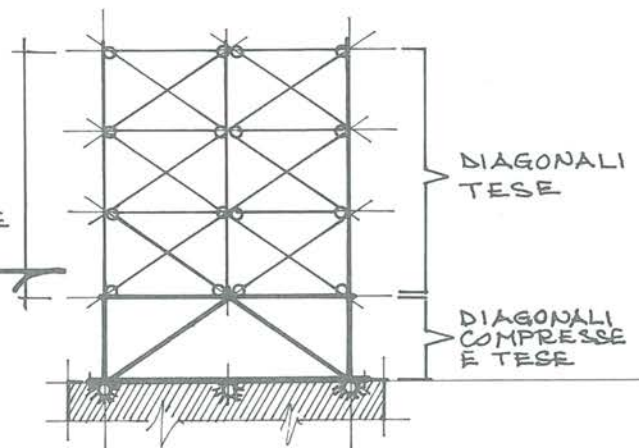

6 - DIAGONALE E CONTRODIAGONALE
 SU UN PIANO
 (DISPOSTE IN UNA CAMPATA E A SCACCHIERA)

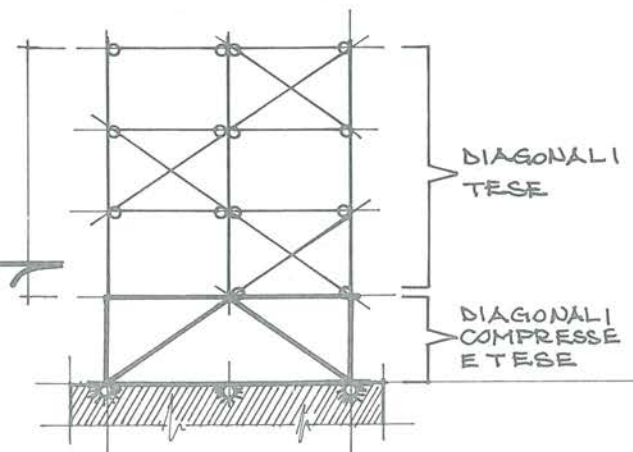

CONTROVENTI VERTICALI RETICOLARI
CON DIAGONALI A K
(DIAGONALI COMPRESSE E TESE)

-EDIFICI CIVILI-

7 - DIAGONALI DISPOSTE IN UNA CAMPATA
(SU UN PIANO)

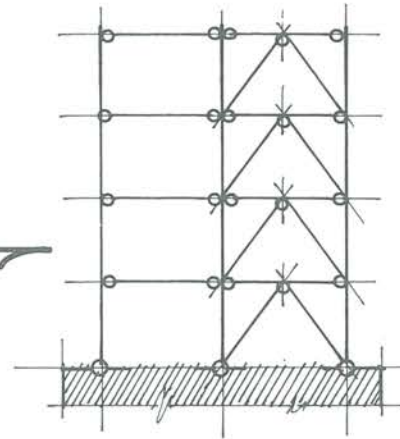

8 - DIAGONALI DISPOSTE IN DUE CAMPATE
(SU UN PIANO)

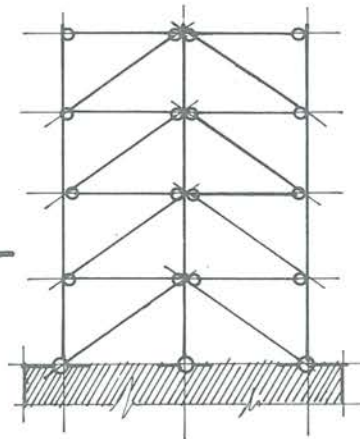

9 - DIAGONALI DISPOSTE IN DUE CAMPATE
(SU UN PIANO)

STRUTTURA RETICOLARE A NODI RIGIDI
VINCOLATA ALLE FONDAZIONI E AVENTE
"SCHEMA A K CONTRAVERSO INFERIORE
IN ACCIAIO"

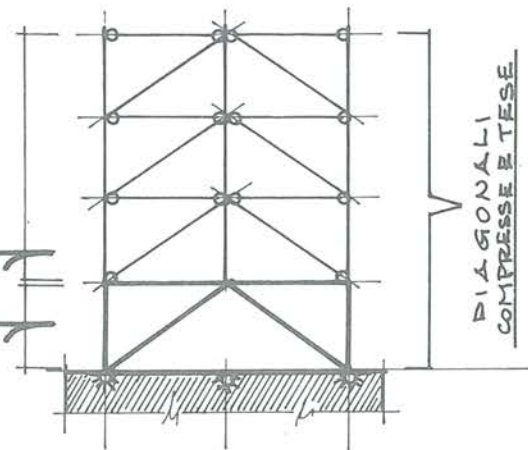

CONTROVENTI VERTICALI RETICOLARI "A NODI ECCENTRICI"
PER EDIFICI CIVILI

- CONTROVENTO CON DIAGONALI
A CROCE DI SANT'ANDREA

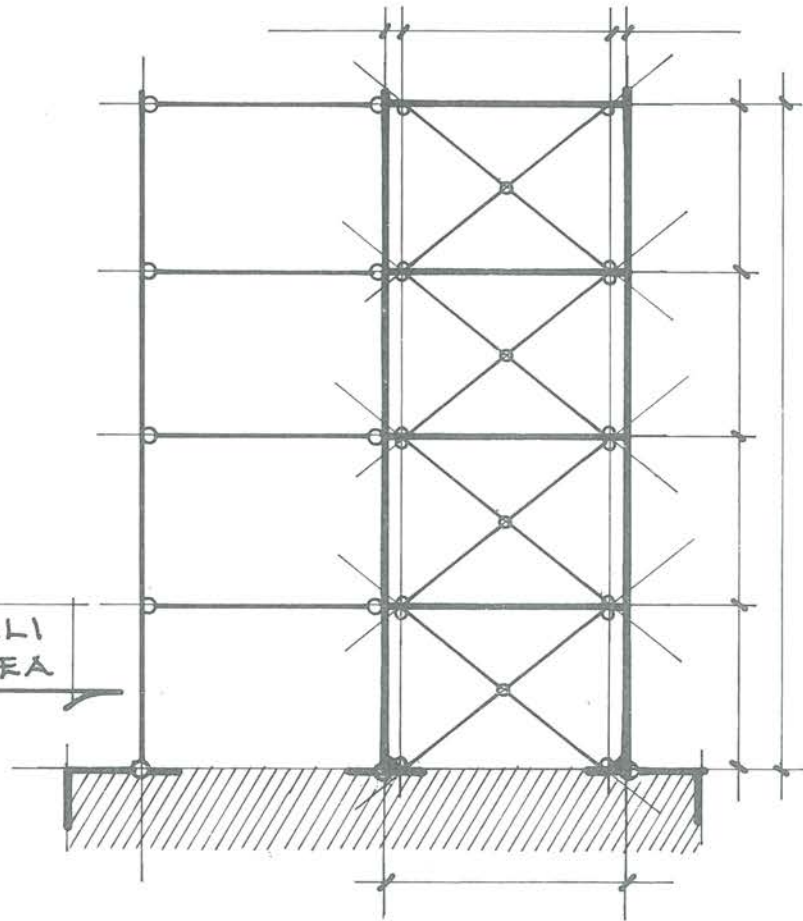

- CONTROVENTO CON DIAGONALI
A K

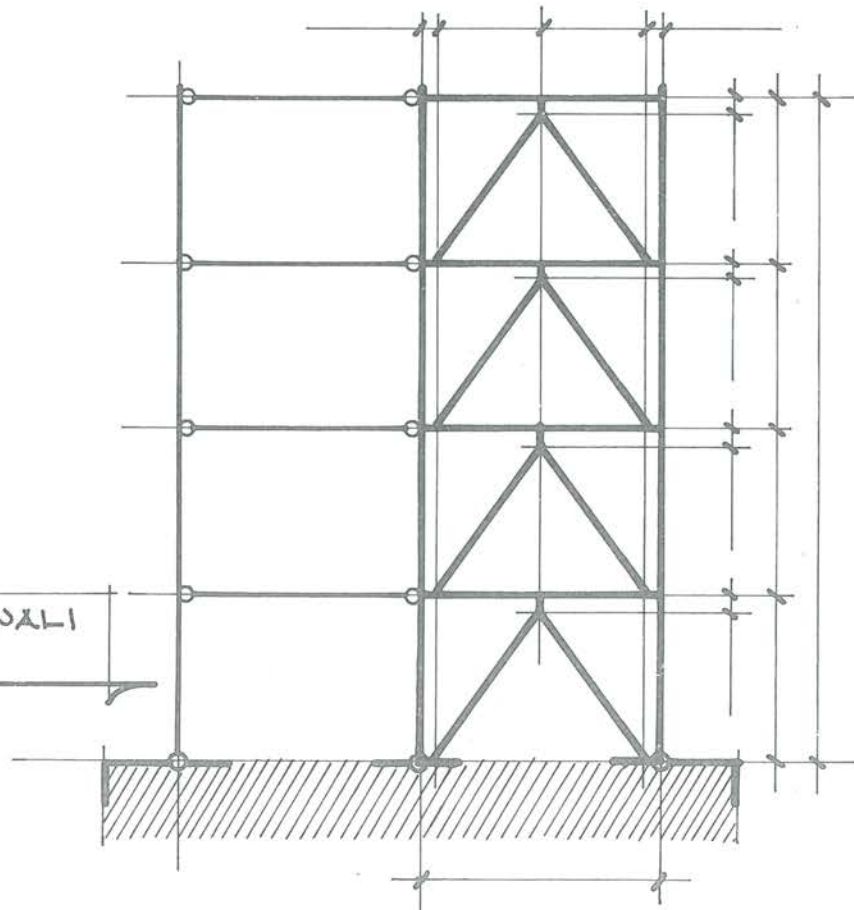

CONTROVENTO VERTICALE RETICOLARE
"A NODI ECCENTRICI" CON DIAGONALI A CROCE DI SANT'ANDREA

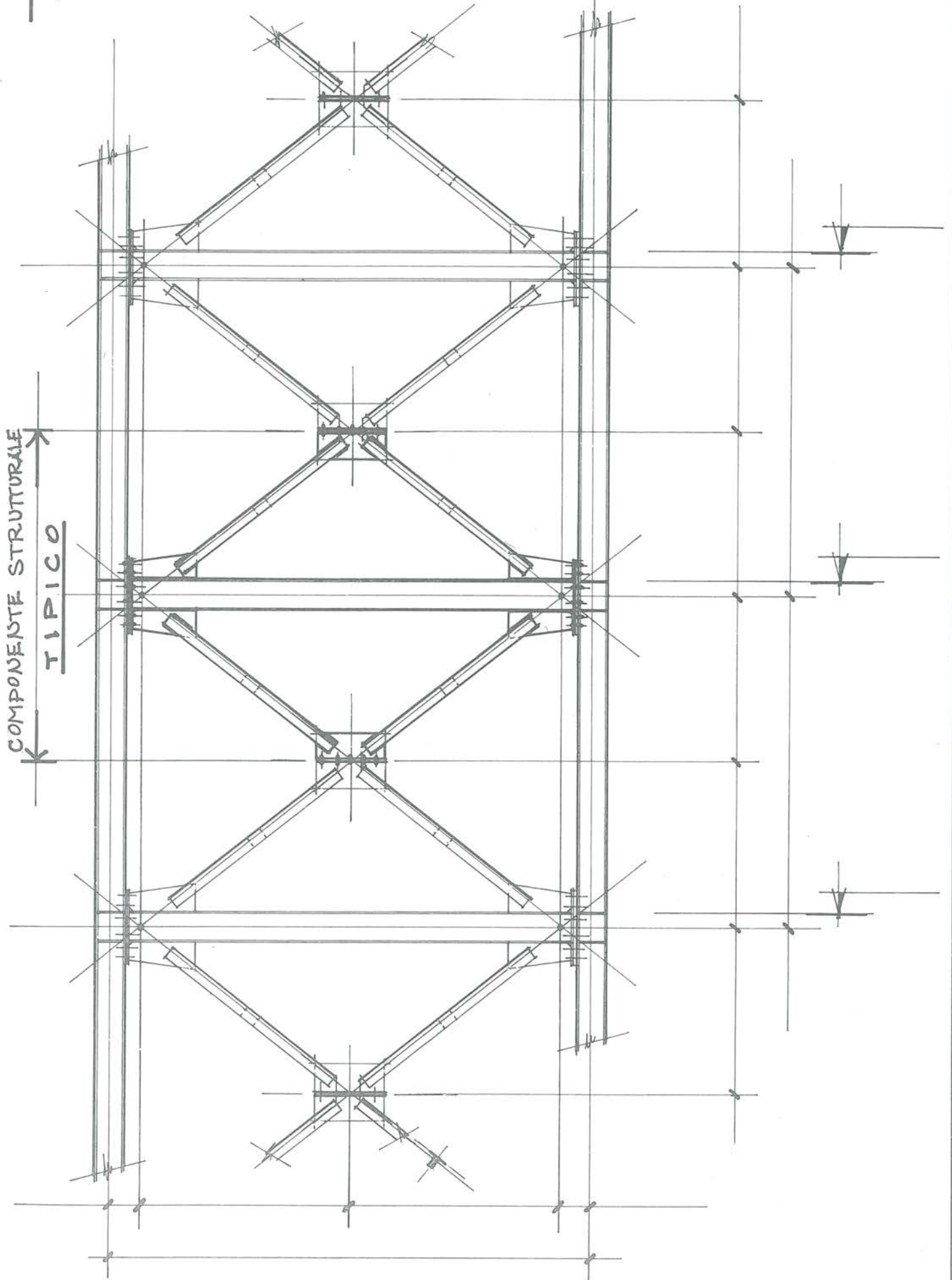

CONTROVENTO VERTICALE RETICOLARE
"A NODI ECCENTRICI" CON DIAGONALI A K

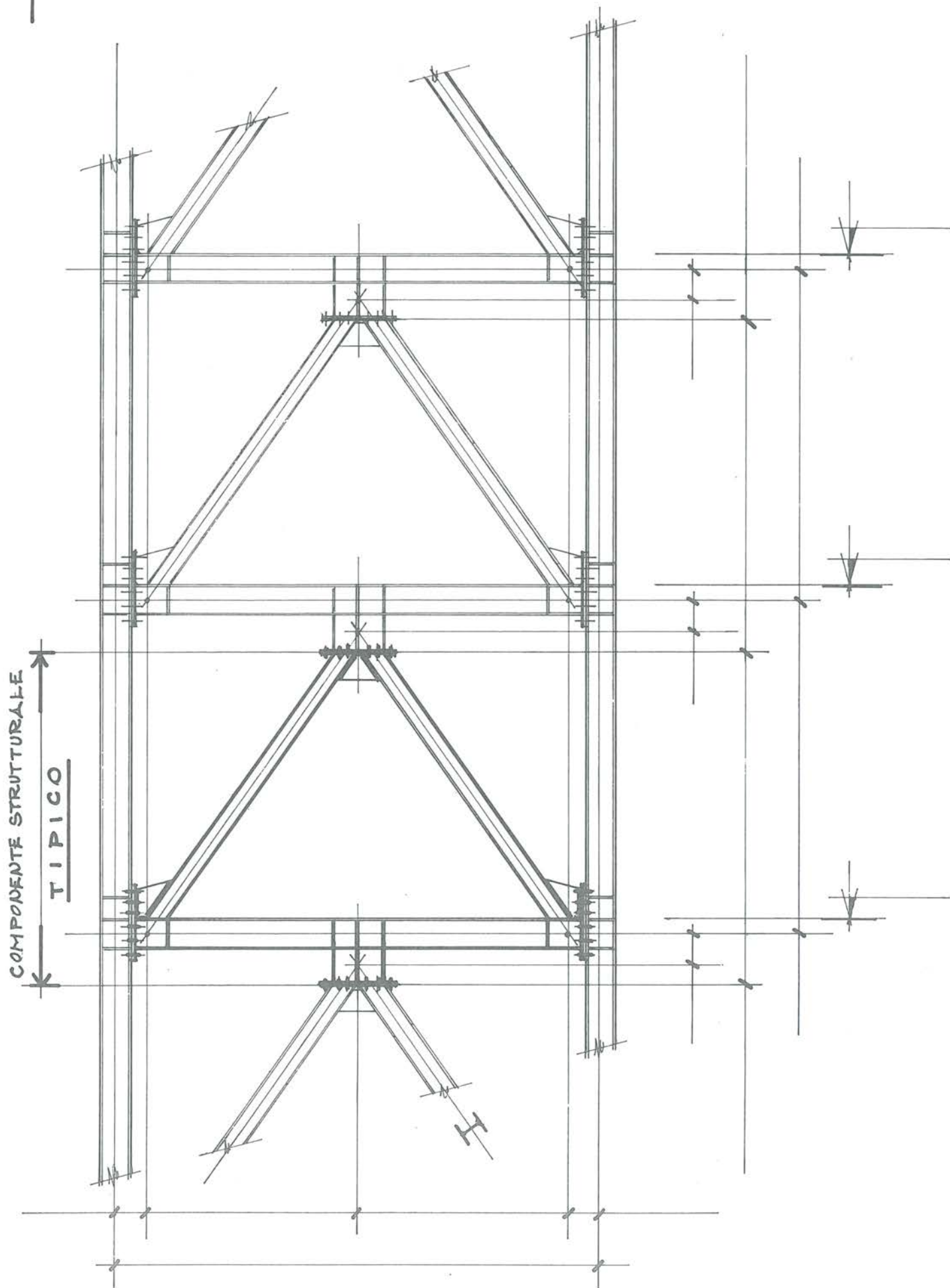

COMPONENTI STRUTTURALI (TIPICO)
REALIZZATI IN OFFICINA MEDIANTE SALDATURA
E DA ASSEMBLARE IN OPERA MEDIANTE BULLONATURA

