



Corso di Bioingegneria Meccanica

Esercitazione 1 (15 Ottobre 2018)

Allievo: _____ Matricola _____

Si proceda al calcolo delle reazioni vincolari per le seguenti strutture isostatiche

1

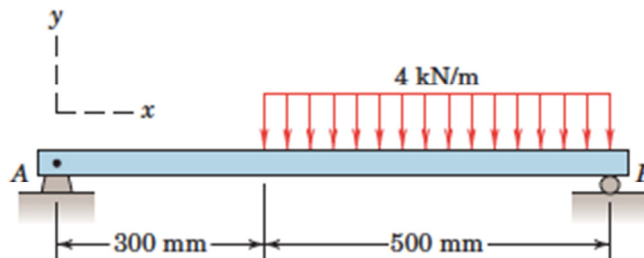

2

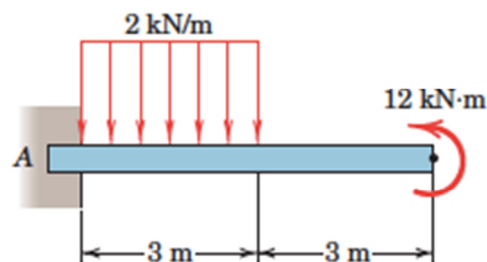

3

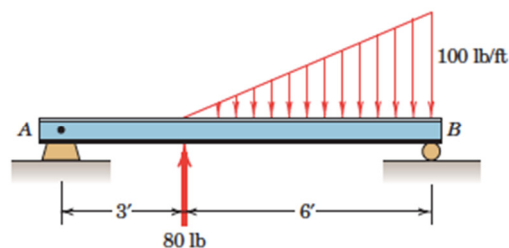



4

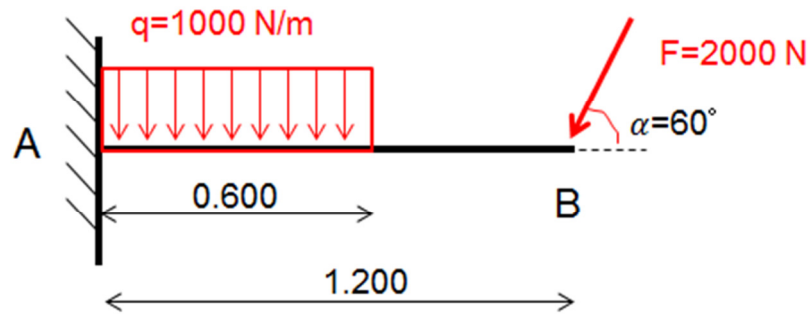

5

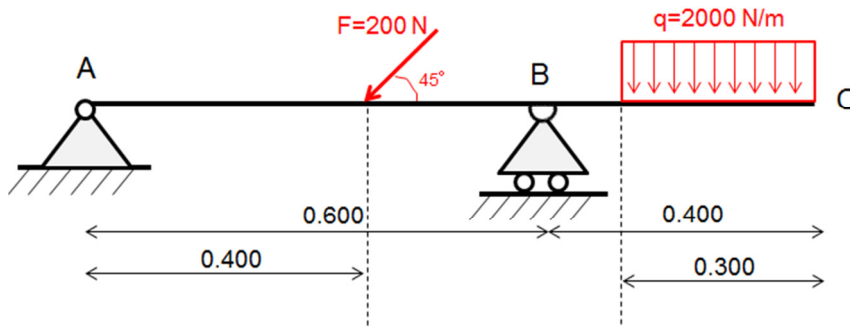

6

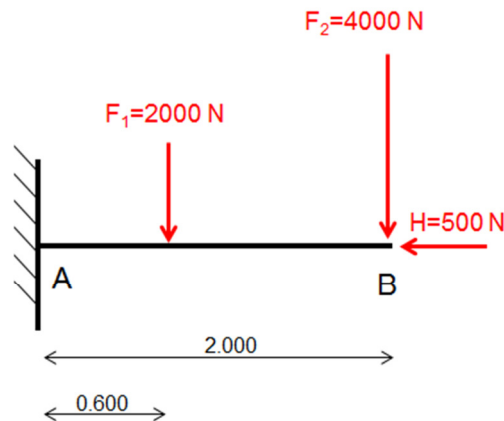



7

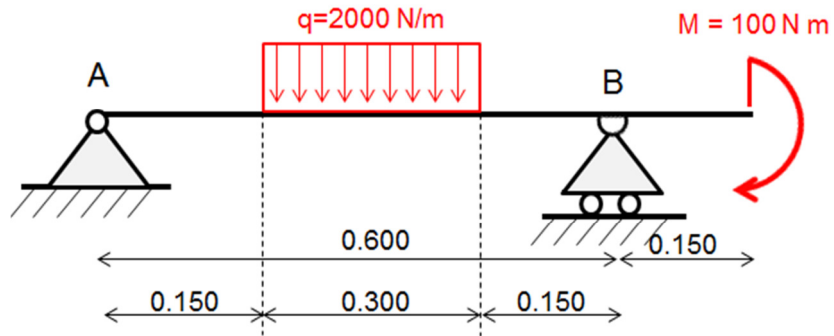

8

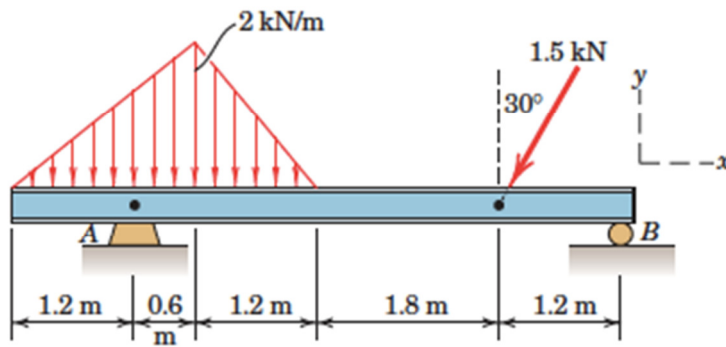

9

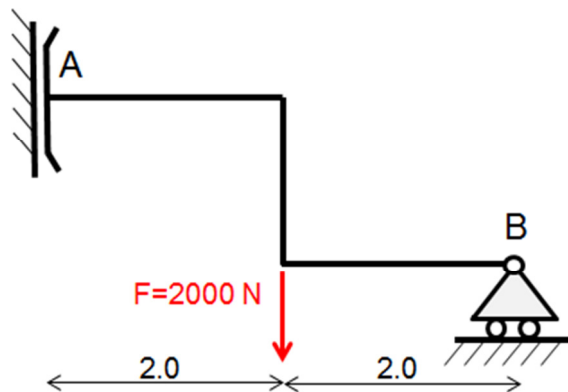



10

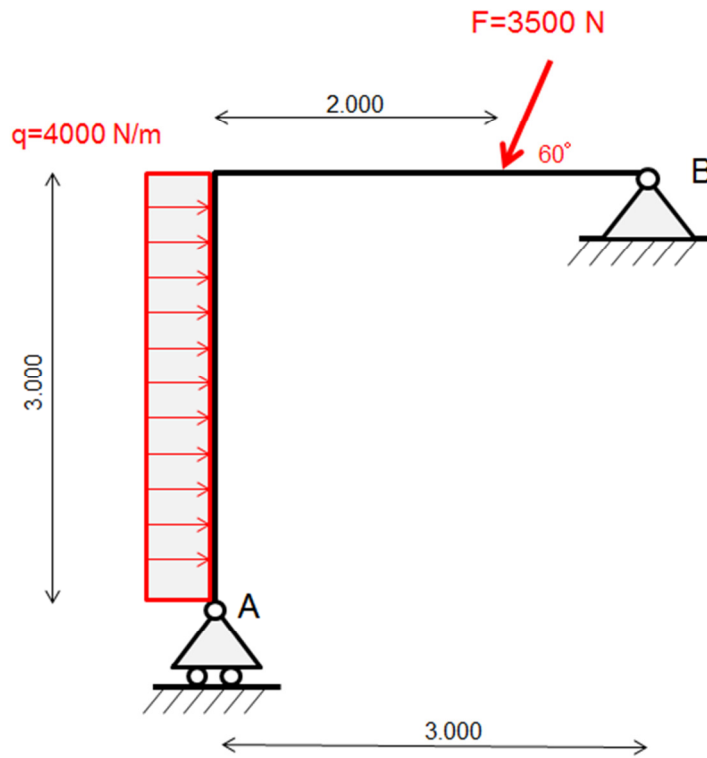

0

