



## Modulo di Costruzioni Biomeccaniche

### Esercitazione 1 (16 Ottobre 2015)

Allievo: \_\_\_\_\_ Matricola \_\_\_\_\_

Si proceda al calcolo delle reazioni vincolari per le seguenti strutture isostatiche

1

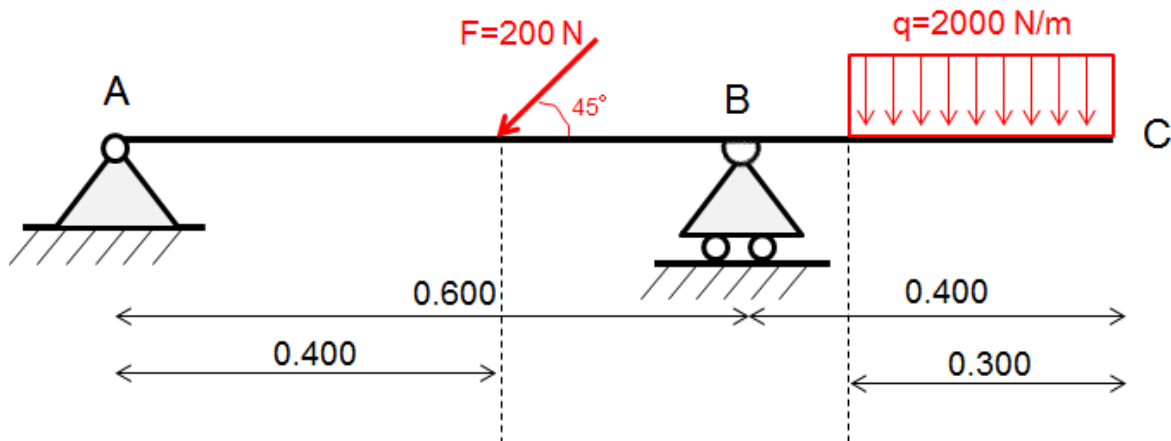

2

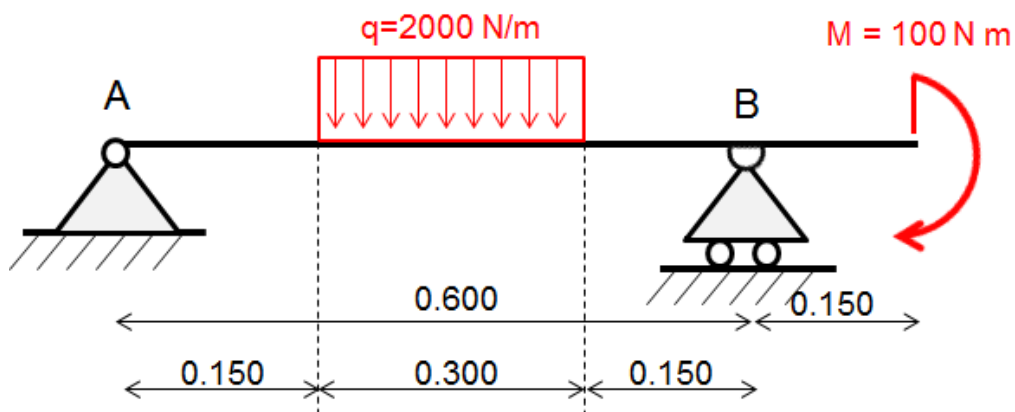



3

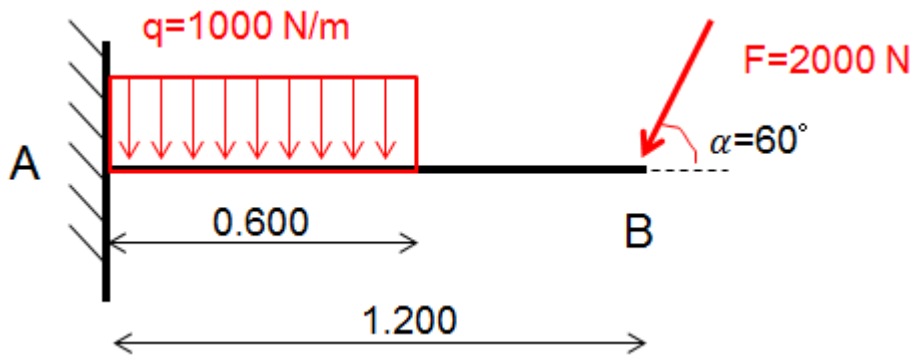

4

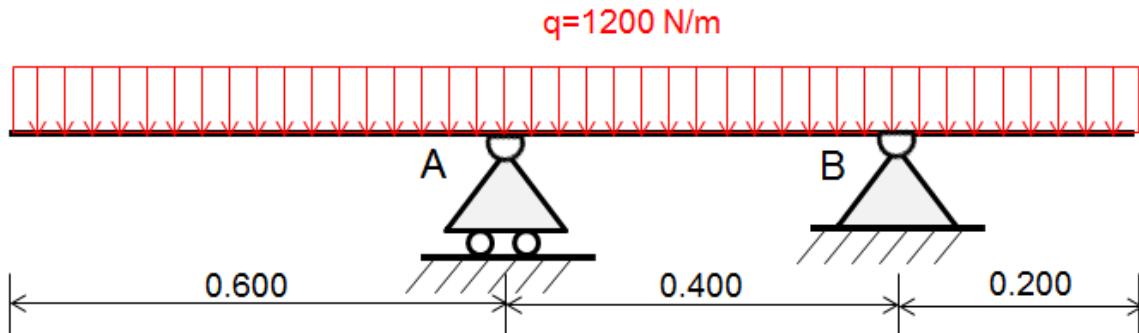

5

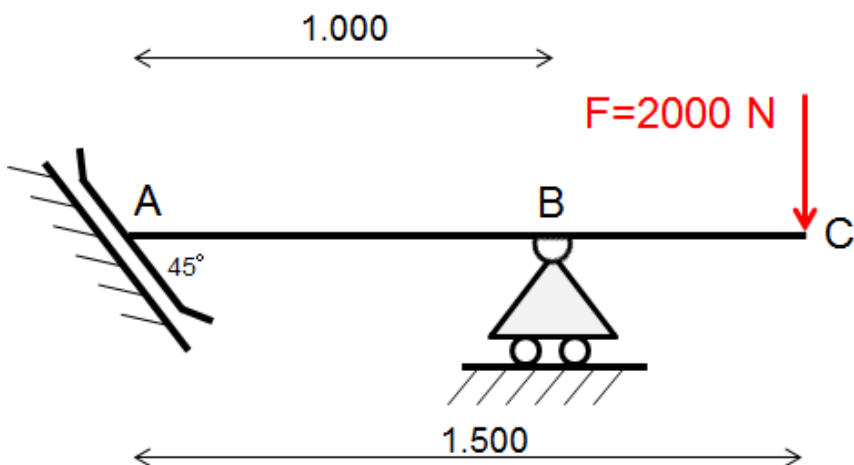



6

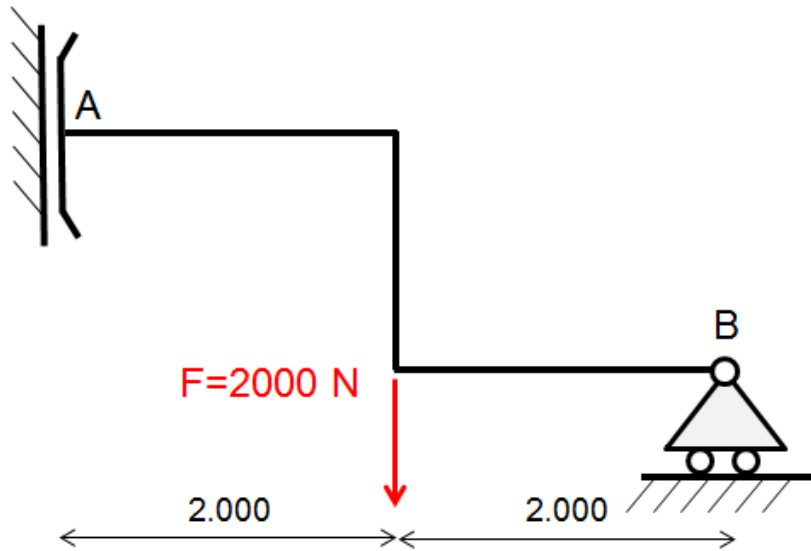

7

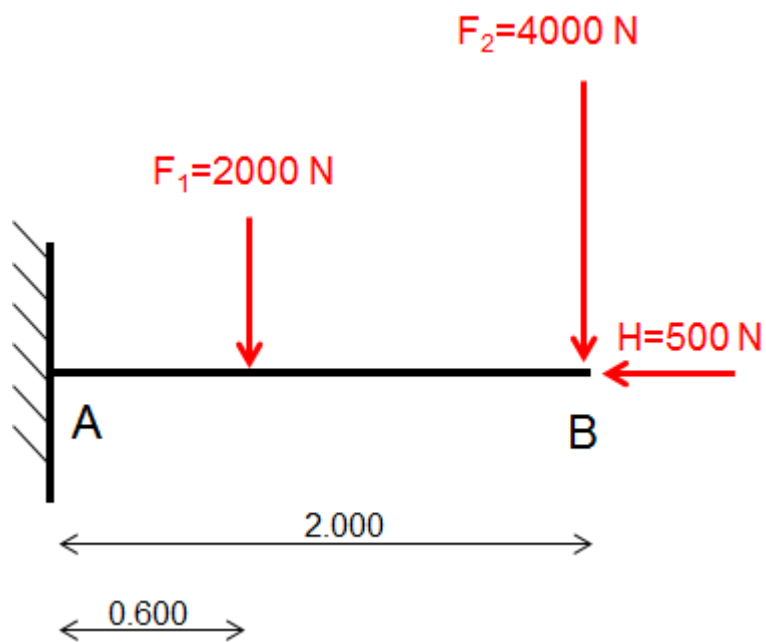



8

